

TBS1000B and TBS1000B-EDU Series Digital Storage Oscilloscopes

User Manual



077-0886-00

Tektronix

**TBS1000B and TBS1000B-EDU Series
Digital Storage Oscilloscopes
User Manual**

Copyright © Tektronix. All rights reserved. Licensed software products are owned by Tektronix or its subsidiaries or suppliers, and are protected by national copyright laws and international treaty provisions.

Tektronix products are covered by U.S. and foreign patents, issued and pending. Information in this publication supersedes that in all previously published material. Specifications and price change privileges reserved.

TEKTRONIX and TEK are registered trademarks of Tektronix, Inc.

OpenChoice™ is a registered trademark of Tektronix, Inc.

PictBridge is a registered trademark of the Standard of Camera & Imaging Products Association CIPA DC-001-2003 Digital Photo Solutions for Imaging Devices.

Contacting Tektronix

Tektronix, Inc.
14150 SW Karl Braun Drive
P.O. Box 500
Beaverton, OR 97077
USA

For product information, sales, service, and technical support:

- In North America, call 1-800-833-9200.
- Worldwide, visit www.tektronix.com to find contacts in your area.

Warranty

Tektronix warrants that the product will be free from defects in materials and workmanship for a period of five (5) years from the date of original purchase from an authorized Tektronix distributor. If the product proves defective during this warranty period, Tektronix, at its option, either will repair the defective product without charge for parts and labor, or will provide a replacement in exchange for the defective product. Batteries are excluded from this warranty. Parts, modules and replacement products used by Tektronix for warranty work may be new or reconditioned to like new performance. All replaced parts, modules and products become the property of Tektronix.

In order to obtain service under this warranty, Customer must notify Tektronix of the defect before the expiration of the warranty period and make suitable arrangements for the performance of service. Customer shall be responsible for packaging and shipping the defective product to the service center designated by Tektronix, shipping charges prepaid, and with a copy of customer proof of purchase. Tektronix shall pay for the return of the product to Customer if the shipment is to a location within the country in which the Tektronix service center is located. Customer shall be responsible for paying all shipping charges, duties, taxes, and any other charges for products returned to any other locations.

This warranty shall not apply to any defect, failure or damage caused by improper use or improper or inadequate maintenance and care. Tektronix shall not be obligated to furnish service under this warranty a) to repair damage resulting from attempts by personnel other than Tektronix representatives to install, repair or service the product; b) to repair damage resulting from improper use or connection to incompatible equipment; c) to repair any damage or malfunction caused by the use of non-Tektronix supplies; or d) to service a product that has been modified or integrated with other products when the effect of such modification or integration increases the time or difficulty of servicing the product.

THIS WARRANTY IS GIVEN BY TEKTRONIX WITH RESPECT TO THE PRODUCT IN LIEU OF ANY OTHER WARRANTIES, EXPRESS OR IMPLIED. TEKTRONIX AND ITS VENDORS DISCLAIM ANY IMPLIED WARRANTIES OF MERCHANTABILITY OR FITNESS FOR A PARTICULAR PURPOSE. TEKTRONIX' RESPONSIBILITY TO REPAIR OR REPLACE DEFECTIVE PRODUCTS IS THE SOLE AND EXCLUSIVE REMEDY PROVIDED TO THE CUSTOMER FOR BREACH OF THIS WARRANTY. TEKTRONIX AND ITS VENDORS WILL NOT BE LIABLE FOR ANY INDIRECT, SPECIAL, INCIDENTAL, OR CONSEQUENTIAL DAMAGES IRRESPECTIVE OF WHETHER TEKTRONIX OR THE VENDOR HAS ADVANCE NOTICE OF THE POSSIBILITY OF SUCH DAMAGES.

[W19 – 03AUG12]

Warranty

Tektronix warrants that this product will be free from defects in materials and workmanship for a period of one (1) year from the date of shipment. If any such product proves defective during this warranty period, Tektronix, at its option, either will repair the defective product without charge for parts and labor, or will provide a replacement in exchange for the defective product. Parts, modules and replacement products used by Tektronix for warranty work may be new or reconditioned to like new performance. All replaced parts, modules and products become the property of Tektronix.

In order to obtain service under this warranty, Customer must notify Tektronix of the defect before the expiration of the warranty period and make suitable arrangements for the performance of service. Customer shall be responsible for packaging and shipping the defective product to the service center designated by Tektronix, with shipping charges prepaid. Tektronix shall pay for the return of the product to Customer if the shipment is to a location within the country in which the Tektronix service center is located. Customer shall be responsible for paying all shipping charges, duties, taxes, and any other charges for products returned to any other locations.

This warranty shall not apply to any defect, failure or damage caused by improper use or improper or inadequate maintenance and care. Tektronix shall not be obligated to furnish service under this warranty a) to repair damage resulting from attempts by personnel other than Tektronix representatives to install, repair or service the product; b) to repair damage resulting from improper use or connection to incompatible equipment; c) to repair any damage or malfunction caused by the use of non-Tektronix supplies; or d) to service a product that has been modified or integrated with other products when the effect of such modification or integration increases the time or difficulty of servicing the product.

THIS WARRANTY IS GIVEN BY TEKTRONIX WITH RESPECT TO THE PRODUCT IN LIEU OF ANY OTHER WARRANTIES, EXPRESS OR IMPLIED. TEKTRONIX AND ITS VENDORS DISCLAIM ANY IMPLIED WARRANTIES OF MERCHANTABILITY OR FITNESS FOR A PARTICULAR PURPOSE. TEKTRONIX' RESPONSIBILITY TO REPAIR OR REPLACE DEFECTIVE PRODUCTS IS THE SOLE AND EXCLUSIVE REMEDY PROVIDED TO THE CUSTOMER FOR BREACH OF THIS WARRANTY. TEKTRONIX AND ITS VENDORS WILL NOT BE LIABLE FOR ANY INDIRECT, SPECIAL, INCIDENTAL, OR CONSEQUENTIAL DAMAGES IRRESPECTIVE OF WHETHER TEKTRONIX OR THE VENDOR HAS ADVANCE NOTICE OF THE POSSIBILITY OF SUCH DAMAGES.

[W2 – 15AUG04]

Table of Contents

Important safety information	iv
General safety summary	iv
Service safety summary	vii
Terms in this manual	viii
Symbols and terms on the product	viii
Compliance information	ix
EMC compliance	ix
Safety compliance	xi
Environmental considerations	xiv
Getting Started	1
General Features	1
Installation	2
Functional Check	4
Probe Safety	5
Manual Probe Compensation	6
Probe Attenuation Setting	6
Current Probe Scaling	7
Self Calibration	7
Firmware Updates Through the Internet	8
Operating Basics	9
Display Area	9
Using the Menu System	12
Vertical Controls	12
Horizontal Controls	12
Trigger Controls	13
Menu and Control Buttons	14
Input Connectors	15
Other Front-Panel Items	16
Understanding Oscilloscope Functions	17
Setting Up the Oscilloscope	17
Triggering	18
Acquiring Signals	20
Scaling and Positioning Waveforms	21
Taking Measurements	23
Application Examples	25
Taking Simple Measurements	26
Using Autorange to Examine a Series of Test Points	30
Taking Cursor Measurements	30
Analyzing Signal Detail	35

Capturing a Single-Shot Signal	36
Measuring Propagation Delay	38
Triggering on a Specific Pulse Width.....	39
Triggering on a Video Signal	41
Analyzing a Differential Communication Signal.....	45
Viewing Impedance Changes in a Network.....	46
Data Logging (non-EDU models only).....	48
Limit Testing (non-EDU models only).....	49
FFT.....	51
Setting Up the Time-Domain Waveform.....	51
Displaying the FFT Spectrum	53
Selecting an FFT Window	54
Magnifying and Positioning an FFT Spectrum.....	57
Measuring an FFT Spectrum Using Cursors.....	58
USB Flash Drive and Device Ports.....	59
USB Flash Drive Port	59
File Management Conventions.....	60
Saving and Recalling Files With a USB Flash Drive.....	61
Using the Save Function of the Front-Panel Save Button.....	63
USB Device Port.....	65
Installing the PC Communications Software on a PC	65
Connecting to a PC	66
Connecting to a GPIB System.....	67
Command Entry.....	68
Reference	69
Acquire.....	69
Autorange.....	71
Autoset	73
Counter.....	76
Course (EDU models only).....	77
Cursor	79
Default Setup.....	80
Display	80
FFT	82
Function.....	82
Help	84
Horizontal.....	84
Math	84
Measure	85
Measurement Gating	89
Menu Off	90

Print-Ready Screenshots	90
Reference Menu.....	90
Save/Recall	91
Trend Plot (non-EDU models only)	95
Trigger Controls.....	96
Utility	101
Vertical Controls	106
Zoom Controls	107
Appendix A: Specifications	109
Oscilloscope Specifications.....	109
Appendix B: TPP0051, TPP0101 and TPP0201 Series 10X Passive Probes Information	113
Connecting the Probe to the Oscilloscope	113
Compensating the Probe	113
Connecting the Probe to the Circuit	114
Standard Accessories	115
Optional Accessories	116
Specifications.....	116
Performance Graphs.....	117
Safety Summary	118
Appendix C: Accessories	121
Appendix D: Cleaning	123
General Care	123
Cleaning	123
Appendix E: Default Setup	125
Appendix F: Font Licenses	127
Index	

Important safety information

This manual contains information and warnings that must be followed by the user for safe operation and to keep the product in a safe condition.

To safely perform service on this product, additional information is provided at the end of this section. (See page vii, *Service safety summary*.)

General safety summary

Use the product only as specified. Review the following safety precautions to avoid injury and prevent damage to this product or any products connected to it. Carefully read all instructions. Retain these instructions for future reference.

Comply with local and national safety codes.

For correct and safe operation of the product, it is essential that you follow generally accepted safety procedures in addition to the safety precautions specified in this manual.

The product is designed to be used by trained personnel only.

Only qualified personnel who are aware of the hazards involved should remove the cover for repair, maintenance, or adjustment.

Before use, always check the product with a known source to be sure it is operating correctly.

This product is not intended for detection of hazardous voltages.

Use personal protective equipment to prevent shock and arc blast injury where hazardous live conductors are exposed.

While using this product, you may need to access other parts of a larger system. Read the safety sections of the other component manuals for warnings and cautions related to operating the system.

When incorporating this equipment into a system, the safety of that system is the responsibility of the assembler of the system.

To avoid fire or personal injury

Use proper power cord. Use only the power cord specified for this product and certified for the country of use.

Do not use the provided power cord for other products.

Ground the product. This product is grounded through the grounding conductor of the power cord. To avoid electric shock, the grounding conductor must be connected to earth ground. Before making connections to the input or output terminals of the product, make sure that the product is properly grounded.

Do not disable the power cord grounding connection.

Power disconnect. The power switch disconnects the product from the power source. See instructions for the location. Do not position the equipment so that it is difficult to disconnect the power switch; it must remain accessible to the user at all times to allow for quick disconnection if needed.

Connect and disconnect properly. Do not connect or disconnect probes or test leads while they are connected to a voltage source.

Use only insulated voltage probes, test leads, and adapters supplied with the product, or indicated by Tektronix to be suitable for the product.

Observe all terminal ratings. To avoid fire or shock hazard, observe all ratings and markings on the product. Consult the product manual for further ratings information before making connections to the product. Do not exceed the Measurement Category (CAT) rating and voltage or current rating of the lowest rated individual component of a product, probe, or accessory. Use caution when using 1:1 test leads because the probe tip voltage is directly transmitted to the product.

Do not apply a potential to any terminal, including the common terminal, that exceeds the maximum rating of that terminal.

Do not float the common terminal above the rated voltage for that terminal.

Do not operate without covers. Do not operate this product with covers or panels removed, or with the case open. Hazardous voltage exposure is possible.

Avoid exposed circuitry. Do not touch exposed connections and components when power is present.

Do not operate with suspected failures. If you suspect that there is damage to this product, have it inspected by qualified service personnel.

Disable the product if it is damaged. Do not use the product if it is damaged or operates incorrectly. If in doubt about safety of the product, turn it off and disconnect the power cord. Clearly mark the product to prevent its further operation.

Before use, inspect voltage probes, test leads, and accessories for mechanical damage and replace when damaged. Do not use probes or test leads if they are damaged, if there is exposed metal, or if a wear indicator shows.

Examine the exterior of the product before you use it. Look for cracks or missing pieces.

Use only specified replacement parts.

Use proper fuse. Use only the fuse type and rating specified for this product.

Wear eye protection. Wear eye protection if exposure to high-intensity rays or laser radiation exists.

Do not operate in wet/damp conditions. Be aware that condensation may occur if a unit is moved from a cold to a warm environment.

Do not operate in an explosive atmosphere.

Keep product surfaces clean and dry. Remove the input signals before you clean the product.

Provide proper ventilation. Refer to the installation instructions in the manual for details on installing the product so it has proper ventilation.

Slots and openings are provided for ventilation and should never be covered or otherwise obstructed. Do not push objects into any of the openings.

Provide a safe working environment. Always place the product in a location convenient for viewing the display and indicators.

Avoid improper or prolonged use of keyboards, pointers, and button pads. Improper or prolonged keyboard or pointer use may result in serious injury.

Be sure your work area meets applicable ergonomic standards. Consult with an ergonomics professional to avoid stress injuries.

Probes and test leads

Before connecting probes or test leads, connect the power cord from the power connector to a properly grounded power outlet.

Keep fingers behind the finger guards on the probes.

Remove all probes, test leads and accessories that are not in use.

Use only correct Measurement Category (CAT), voltage, temperature, altitude, and amperage rated probes, test leads, and adapters for any measurement.

Beware of high voltages. Understand the voltage ratings for the probe you are using and do not exceed those ratings. Two ratings are important to know and understand:

- The maximum measurement voltage from the probe tip to the probe reference lead.
- The maximum floating voltage from the probe reference lead to earth ground

These two voltage ratings depend on the probe and your application. Refer to the Specifications section of the manual for more information.



WARNING. *To prevent electrical shock, do not exceed the maximum measurement or maximum floating voltage for the oscilloscope input BNC connector, probe tip, or probe reference lead.*

Connect and disconnect properly. Connect the probe output to the measurement product before connecting the probe to the circuit under test. Connect the probe reference lead to the circuit under test before connecting the probe input. Disconnect the probe input and the probe reference lead from the circuit under test before disconnecting the probe from the measurement product.

Connect and disconnect properly. De-energize the circuit under test before connecting or disconnecting the current probe.

Connect the probe reference lead to earth ground only.

Do not connect a current probe to any wire that carries voltages above the current probe voltage rating.

Inspect the probe and accessories. Before each use, inspect probe and accessories for damage (cuts, tears, or defects in the probe body, accessories, or cable jacket). Do not use if damaged.

Ground-referenced oscilloscope use. Do not float the reference lead of this probe when using with ground-referenced oscilloscopes. The reference lead must be connected to earth potential (0 V).

Service safety summary

The *Service safety summary* section contains additional information required to safely perform service on the product. Only qualified personnel should perform service procedures. Read this *Service safety summary* and the *General safety summary* before performing any service procedures.

To avoid electric shock. Do not touch exposed connections.

Do not service alone. Do not perform internal service or adjustments of this product unless another person capable of rendering first aid and resuscitation is present.

Disconnect power. To avoid electric shock, switch off the product power and disconnect the power cord from the mains power before removing any covers or panels, or opening the case for servicing.

Use care when servicing with power on. Dangerous voltages or currents may exist in this product. Disconnect power, remove battery (if applicable), and disconnect test leads before removing protective panels, soldering, or replacing components.

Verify safety after repair. Always recheck ground continuity and mains dielectric strength after performing a repair.

Terms in this manual

These terms may appear in this manual:



WARNING. *Warning statements identify conditions or practices that could result in injury or loss of life.*



CAUTION. *Caution statements identify conditions or practices that could result in damage to this product or other property.*

Symbols and terms on the product

These terms may appear on the product:

- DANGER indicates an injury hazard immediately accessible as you read the marking.
- WARNING indicates an injury hazard not immediately accessible as you read the marking.
- CAUTION indicates a hazard to property including the product.



When this symbol is marked on the product, be sure to consult the manual to find out the nature of the potential hazards and any actions which have to be taken to avoid them. (This symbol may also be used to refer the user to ratings in the manual.)

The following symbol(s) may appear on the product:

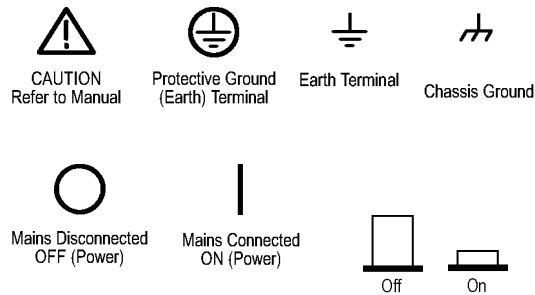

Compliance information

This section lists the EMC (electromagnetic compliance), safety, and environmental standards with which the instrument complies.

EMC compliance

EC Declaration of Conformity – EMC

Meets intent of Directive 2004/108/EC for Electromagnetic Compatibility. Compliance was demonstrated to the following specifications as listed in the Official Journal of the European Communities:

EN 61326-1:2006, EN 61326-2-1:2006. EMC requirements for electrical equipment for measurement, control, and laboratory use. ^{1 2 3}

- CISPR 11:2003. Radiated and conducted emissions, Group 1, Class A
- IEC 61000-4-2:2001. Electrostatic discharge immunity
- IEC 61000-4-3:2002. RF electromagnetic field immunity ⁴
- IEC 61000-4-4:2004. Electrical fast transient/burst immunity
- IEC 61000-4-5:2001. Power line surge immunity
- IEC 61000-4-6:2003. Conducted RF immunity ⁵
- IEC 61000-4-11:2004. Voltage dips and interruptions immunity ⁶

EN 61000-3-2:A1/A2 2009. AC power line harmonic emissions

EN 61000-3-3:2008. Voltage changes, fluctuations, and flicker

European contact.

Tektronix UK, Ltd.
Western Peninsula
Western Road
Bracknell, RG12 1RF
United Kingdom

EMC compliance

Meets the intent of Directive 2004/108/EC for Electromagnetic Compatibility when it is used with the product(s) stated in the specifications table. Refer to the EMC specification published for the stated products. May not meet the intent of the directive if used with other products.

European contact.

Tektronix UK, Ltd.
Western Peninsula
Western Road
Bracknell, RG12 1RF

United Kingdom

- 1 This product is intended for use in nonresidential areas only. Use in residential areas may cause electromagnetic interference.
- 2 Emissions which exceed the levels required by this standard may occur when this equipment is connected to a test object.
- 3 To ensure compliance with the EMC standards listed here, high quality shielded interface cables should be used.
- 4 The instrument will exhibit ≤ 3.0 division waveform displacement and ≤ 6.0 division increase in peak-to-peak noise when subjected to radiated interference per IEC 61000-4-3.
- 5 The instrument will exhibit ≤ 2.0 division waveform displacement and ≤ 4.0 division increase in peak-to-peak noise when subjected to conducted interference per IEC 61000-4-6.
- 6 Performance Criterion C applied at the 70%/25 cycle Voltage-Dip and the 0%/250 cycle Voltage-Interruption test levels (IEC 61000-4-11). If the instrument powers down upon a voltage dip or interruption, it will take longer than ten seconds to return to the previous operating state.

Australia / New Zealand Declaration of Conformity – EMC

Complies with the EMC provision of the Radiocommunications Act per the:

- CISPR 11:2003. Radiated and Conducted Emissions, Group 1, Class A, in accordance with EN 61326-1:2006 and EN 61326-2-1:2006.

Australia / New Zealand contact.

Baker & McKenzie
Level 27, AMP Centre
50 Bridge Street
Sydney NSW 2000, Australia

FCC – EMC

Exempt from FCC 47 CFR, Part 15.

Russian Federation

This product is approved by the Russian government to carry the GOST mark.

Safety compliance

This section lists the safety standards with which the product complies and other safety compliance information.

EU declaration of conformity – low voltage

Compliance was demonstrated to the following specification as listed in the Official Journal of the European Union:

Low Voltage Directive 2006/95/EC.

- EN 61010-1. Safety Requirements for Electrical Equipment for Measurement, Control, and Laboratory Use – Part 1: General Requirements.
- EN 61010-2-030. Safety Requirements for Electrical Equipment for Measurement, Control, and Laboratory Use – Part 2-030: Particular requirements for testing and measuring circuits.
- EN 61010-031. Particular requirements for handheld probe assemblies for electrical measurement and test equipment.

U.S. nationally recognized testing laboratory listing

- UL 61010-1. Safety Requirements for Electrical Equipment for Measurement, Control, and Laboratory Use – Part 1: General Requirements.
- UL 61010-2-030. Safety Requirements for Electrical Equipment for Measurement, Control, and Laboratory Use – Part 2-030: Particular requirements for testing and measuring circuits.
- UL 61010-031. Particular requirements for handheld probe assemblies for electrical measurement and test equipment.

Canadian certification

- CAN/CSA-C22.2 No. 61010-1. Safety Requirements for Electrical Equipment for Measurement, Control, and Laboratory Use – Part 1: General Requirements.
- CAN/CSA-C22.2 No. 61010-2-030. Safety Requirements for Electrical Equipment for Measurement, Control, and Laboratory Use – Part 2-030: Particular requirements for testing and measuring circuits.
- CAN/CSA-C22.2 No. 61010-031. Particular requirements for handheld probe assemblies for electrical measurement and test equipment.

Additional compliances	<ul style="list-style-type: none">■ IEC 61010-1. Safety Requirements for Electrical Equipment for Measurement, Control, and Laboratory Use – Part 1: General Requirements.■ IEC 61010-2-030. Safety Requirements for Electrical Equipment for Measurement, Control, and Laboratory Use – Part 2-030: Particular requirements for testing and measuring circuits.■ IEC 61010-031. Particular requirements for handheld probe assemblies for electrical measurement and test equipment.
Equipment type	Test and measuring equipment.
Safety class	Class 1 – grounded product.
Pollution degree descriptions	<p>A measure of the contaminants that could occur in the environment around and within a product. Typically the internal environment inside a product is considered to be the same as the external. Products should be used only in the environment for which they are rated.</p> <ul style="list-style-type: none">■ Pollution degree 1. No pollution or only dry, nonconductive pollution occurs. Products in this category are generally encapsulated, hermetically sealed, or located in clean rooms.■ Pollution degree 2. Normally only dry, nonconductive pollution occurs. Occasionally a temporary conductivity that is caused by condensation must be expected. This location is a typical office/home environment. Temporary condensation occurs only when the product is out of service.■ Pollution degree 3. Conductive pollution, or dry, nonconductive pollution that becomes conductive due to condensation. These are sheltered locations where neither temperature nor humidity is controlled. The area is protected from direct sunshine, rain, or direct wind.■ Pollution degree 4. Pollution that generates persistent conductivity through conductive dust, rain, or snow. Typical outdoor locations.
Pollution degree rating	Pollution degree 2 (as defined in IEC 61010-1). Rated for indoor, dry location use only.

Measurement and overvoltage category descriptions

Measurement terminals on this product may be rated for measuring mains voltages from one or more of the following categories (see specific ratings marked on the product and in the manual).

- Category II. Circuits directly connected to the building wiring at utilization points (socket outlets and similar points).
- Category III. In the building wiring and distribution system.
- Category IV. At the source of the electrical supply to the building.

NOTE. *Only mains power supply circuits have an overvoltage category rating. Only measurement circuits have a measurement category rating. Other circuits within the product do not have either rating.*

Mains overvoltage category rating

Overvoltage category II (as defined in IEC 61010-1).

Environmental considerations

This section provides information about the environmental impact of the product.

Product end-of-life handling

Observe the following guidelines when recycling an instrument or component:

Equipment recycling. Production of this equipment required the extraction and use of natural resources. The equipment may contain substances that could be harmful to the environment or human health if improperly handled at the product's end of life. To avoid release of such substances into the environment and to reduce the use of natural resources, we encourage you to recycle this product in an appropriate system that will ensure that most of the materials are reused or recycled appropriately.



This symbol indicates that this product complies with the applicable European Union requirements according to Directives 2002/96/EC and 2006/66/EC on waste electrical and electronic equipment (WEEE) and batteries. For information about recycling options, check the Support/Service section of the Tektronix Web site (www.tektronix.com).

Restriction of hazardous substances

This product is classified as an industrial monitoring and control instrument, and is not required to comply with the substance restrictions of the recast RoHS Directive 2011/65/EU until July 22, 2017.

Getting Started

TBS1000B and TBS1000B-EDU Series Digital Storage Oscilloscopes are small, lightweight, benchtop instruments, which you can use to take ground-referenced measurements.

This chapter describes how to do the following tasks:

- Install your product
- Perform a brief functional check
- Perform a probe check and compensate probes
- Match your probe attenuation factor
- Use the self calibration routine

NOTE. You can select a language to display on the screen when you power on the oscilloscope. At any time, you can also access the **Utility ► Language** option to select a language.

General Features

Model	Channels	Bandwidth	Sample rate	Display
TBS1052B-EDU	2	50 MHz	1 GS/s	Color
TBS1052B	2	50 MHz	1 GS/s	Color
TBS1072B-EDU	2	70 MHz	1 GS/s	Color
TBS1072B	2	70 MHz	1 GS/s	Color
TBS1102B-EDU	2	100 MHz	2 GS/s	Color
TBS1102B	2	100 MHz	2 GS/s	Color
TBS1152B-EDU	2	150 MHz	2 GS/s	Color
TBS1152B	2	150 MHz	2 GS/s	Color
TBS1202B-EDU	2	200 MHz	2 GS/s	Color
TBS1202B	2	200 MHz	2 GS/s	Color

- Context-sensitive help system
- 7-inch color LCD display
- Educational courseware integrated in the instrument (EDU models only)
- Limit tests, data logging, and trend plots (non-EDU models only)
- Counter function
- Selectable 20 MHz bandwidth limit
- 2,500 point record length for each channel

- Autoset
- Autoranging
- Setup and waveform storage
- USB Flash Drive port for file storage
- PC communications through the USB Device port with OpenChoice PC Communications software
- Connect to a GPIB controller through an optional TEK-USB-488 adapter
- Cursors with readouts
- Trigger frequency readout
- 34 automatic measurements — and measurement gating
- Waveform averaging and peak detection
- Math functions: +, -, and \times operations
- Fast Fourier Transform (FFT)
- Pulse Width trigger capability
- Video trigger capability with line-selectable triggering
- External trigger
- Variable persistence display
- User interface and help topics in ten languages
- Zoom feature

Installation

- Power Cord** Use only the power cord provided with your oscilloscope. *Appendix C: Accessories* lists the standard and the optional accessories.
- Power Source** Use a power source that delivers 90 to 264 VAC_{RMS}, 45 to 66 Hz. If you have a 400 Hz power source, it must deliver 90 to 132 VAC_{RMS}, 360 to 440 Hz.
The product's maximum power consumption is 30 W.
- Security Loop** Use a standard laptop computer security lock, or thread a security cable through the built-in cable channel to secure your oscilloscope to your location.

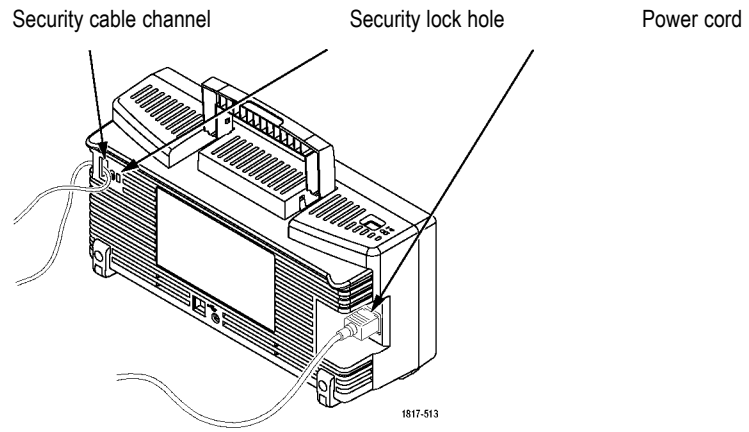

Ventilation

NOTE. *The oscilloscope cools by convection. Keep two inches clear on the sides and top of the product to allow adequate air flow.*

Functional Check

Perform this functional check to verify that your oscilloscope is operating correctly.

ON/OFF button

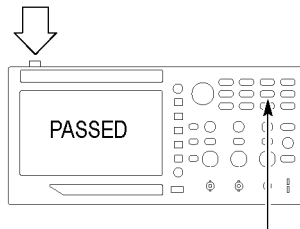

1. Power on the oscilloscope.
Push the **Default Setup** button.
The default Probe option attenuation setting is 10X.

Default Setup button

PROBE COMP

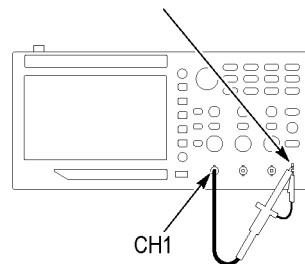

2. Connect the TPP0051, TPP0101, or TP0201 probe to channel 1 on the oscilloscope. To do this, align the slot in the probe connector with the key on the channel 1 BNC, push to connect, and twist to the right to lock the probe in place.
Connect the probe tip and reference lead to the PROBE COMP terminals.

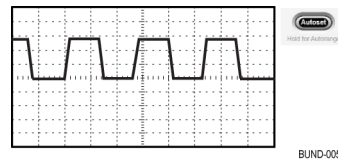

3. Push the **Autoset** button. Within a few seconds, you should see a square wave in the display of about 5V peak-to-peak at 1 kHz.
Push the channel 1 menu button on the front panel twice to remove channel 1, push the channel 2 menu button to display channel 2, and repeat steps 2 and 3.

Calibration: PASSED

4. Check that the instruction passed the calibration tests. Push **Utility** ► **- more - page 1 of 2** (push **more** again on EDU models) ► **System Status** ► **Misc..** Look for **Calibration PASSED**

Probe Safety

Check and observe probe ratings before using probes.

A guard around the TPP0051, TPP0101, or TPP0201 probe body provides a finger barrier for protection from electric shock.

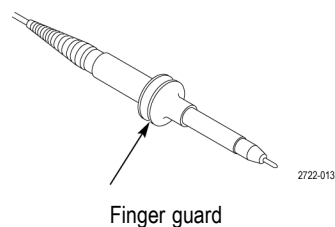

WARNING. *To avoid electric shock when using the probe, keep fingers behind the guard on the probe body.*

To avoid electric shock while using the probe, do not touch metallic portions of the probe head while it is connected to a voltage source.

Connect the probe to the oscilloscope, and connect the ground terminal to ground before you take any measurements.

Manual Probe Compensation

You can manually perform this adjustment to match your probe to the input channel.

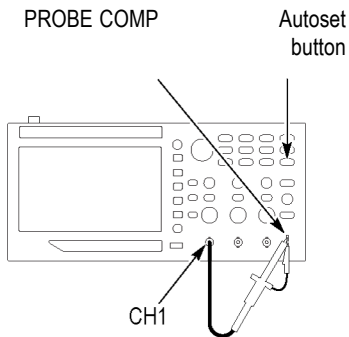

1. Push the **1 ▶ Probe ▶ Voltage ▶ Attenuation** option and select **10X**. Connect the appropriate TPP0051, TPP0101, or TPP0201 probe to channel 1 on the oscilloscope. If you use the probe hook-tip, ensure a proper connection by firmly inserting the tip onto the probe.
2. Attach the probe tip to the PROBE COMP ~5V@1kHz terminal and the reference lead to the PROBE COMP chassis terminal. Display the channel, and then push the **Autoset** button.
3. Check the shape of the displayed waveform.

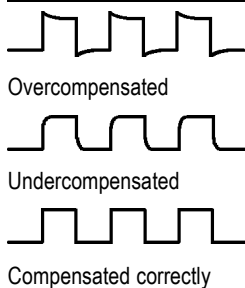

4. If necessary, adjust your probe. Repeat as necessary.

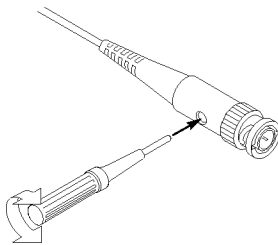

Probe Attenuation Setting

Probes are available with various attenuation factors which affect the vertical scale of the signal.

Select the factor that matches the attenuation of your probe. For example, to match a probe set to 10X connected to CH 1, push the **1 ▶ Probe ▶ Voltage ▶ Attenuation** option, and select **10X**.

NOTE. *The default setting for the Attenuation option is 10X.*

If you change the Attenuation switch on a P2220 probe, you also need to change the oscilloscope Attenuation option to match. Switch settings are 1X and 10X.

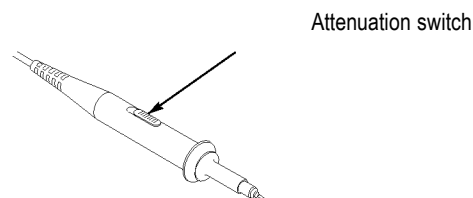

NOTE. When the Attenuation switch is set to 1X, the P2220 probe limits the bandwidth of the oscilloscope to 6 MHz. To use the full bandwidth of the oscilloscope, be sure to set the switch to 10X.

Current Probe Scaling

Current probes provide a voltage signal proportional to the current. You need to set the oscilloscope to match the scale of your current probe. The default scale is 10 A/V.

For example, to set the scale for a current probe connected to channel 1, push the **1 ► Probe ► Current ► Scale** option, and select an appropriate value.

Self Calibration

The self calibration routine lets you optimize the oscilloscope signal path for maximum measurement accuracy. You can run the routine at any time but you should always run the routine if the ambient temperature changes by 5 °C (9 °F) or more. The routine takes about two minutes.

For accurate calibration, power on the oscilloscope and wait twenty minutes to ensure it is warmed up.

To compensate the signal path, disconnect any probes or cables from the input connectors. Then, access the **Utility ► Do Self Cal** option, and follow the directions on the screen.

Firmware Updates Through the Internet

Update your TBS1000B's firmware to take advantage of new features and bug fixes. You can use the Internet and a USB flash drive to update your oscilloscope. If you do not have access to the Internet, contact Tektronix for information on update procedures.

Check the version of your current firmware

1. Power on the oscilloscope.
2. For the TBDS1000B: Push **Utility** ► - **more - page 1 of 2** ► **System Status** ► **Misc.**.

For the TBDS1000B-EDU: Push **Utility** ► - **more - page 1 of 3** ► - **more - page 2 of 3** ► **System Status** ► **Misc.**.

3. The oscilloscope displays the firmware version number.

Check the version of the latest available firmware

1. Open up a Web browser and go to www.tektronix.com/software.
2. Enter "TBS1000B" in the search box.
3. Scan the list of available software for the latest TBS1000B firmware. Check the version number.

If the latest available firmware is newer than that on your TBS1000B, update your product's firmware

1. Download the latest firmware from www.tektronix.com/software to your PC. Unzip the files, if needed, and copy the designated firmware file into the root folder of a USB flash drive.
2. Insert the USB flash drive into the front-panel USB port on your oscilloscope.
3. Push **Utility** ► - **more - page 1 of 2** ► **File Utilities** ► - **more - page 1 of 2** ► **Update Firmware** ► **Update Firmware**

It takes several minutes to update the firmware. Your oscilloscope will prompt you when the update is complete. Do not remove the USB flash drive or power off the oscilloscope until the firmware update is complete.

Operating Basics

The front panel is divided into easy-to-use functional areas. This chapter provides you with a quick overview of the controls and the information displayed on the screen.



Display Area

In addition to displaying waveforms, the display provides details about the waveform and the oscilloscope control settings.

NOTE. For details on displaying the FFT function, (See page 53, *Displaying the FFT Spectrum.*)

The items shown below may appear in the display. Not all of these items are visible at any given time. Some readouts move outside the graticule area when menus are turned off.

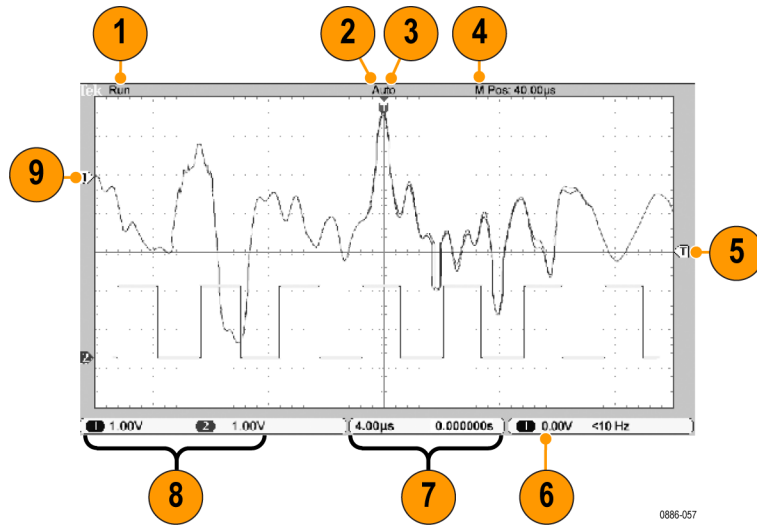

1. The acquisition readout shows when an acquisition is running or stopped. Icons are:
 Run: Acquisition enabled
 Stop: Acquisitions not enabled.
2. The trigger position icon shows the trigger position in the acquisition. Turn the **Horizontal Position** knob to adjust the position of the marker.
3. The trigger status readout shows:
 Armed: The oscilloscope is acquiring pretrigger data. All triggers are ignored in this state.
 Ready: All pretrigger data has been acquired and the oscilloscope is ready to accept a trigger.
 Trig'd: The oscilloscope has seen a trigger and is acquiring the posttrigger data.
 Stop: The oscilloscope has stopped acquiring waveform data.
 Acq. Complete: The oscilloscope has completed a Single Sequence acquisition.
 Auto: The oscilloscope is in auto mode and is acquiring waveforms in the absence of trigger.
 Scan: The oscilloscope is acquiring and displaying waveform data continuously in scan mode.
4. The center graticule readout shows the time at the center graticule. The trigger time is zero.
5. The trigger level icon shows the Edge or Pulse Width trigger level on the waveform. The icon color corresponds to the trigger source color.

6. The trigger readout shows the trigger source, level, and frequency. Trigger readouts for other trigger types show other parameters.
7. The horizontal position/scale readout shows the main time base setting (adjust with the **Horizontal Scale** knob).
8. The channel readout shows the vertical scale factor (per division) for each channel. Adjust with the **Vertical Scale** knob for each channel.
9. The waveform baseline indicator shows the ground reference points (the zero-volt level) of a waveform (ignoring the effect of offset). The icon colors correspond to the waveform colors. If there is no marker, the channel is not displayed.

Message Area

The oscilloscope displays a message area at the bottom of the screen that conveys the following types of helpful information:

- Suggestion of what you might want to do next, such as when you push the **Measure** button and then the **Ch1** button:

Use multipurpose purpose knob to select measurement type

- Information about the action the oscilloscope performed, such as when you push the **Default Setup** button:

Default setup recalled

- Information about the waveform, such as when you push the Autoset button:

Square wave or pulse detected on ch1

Using the Menu System

When you push a front-panel button, the oscilloscope displays the corresponding menu on the right side of the screen. The menu shows the options that are available when you push the unlabeled option buttons directly to the right of the screen.

Vertical Controls

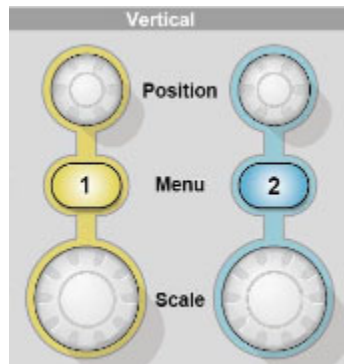

Position (1 and 2). Positions a waveform vertically.

1 & 2 Menu. Displays the Vertical menu selections and toggles the display of the channel waveform on and off.

Scale (1 & 2). Selects vertical scale factors.

Horizontal Controls



Position. Adjusts the horizontal position of all channel and math waveforms. The resolution of this control varies with the time base setting.

NOTE. To make a large adjustment to the horizontal position, turn the **Horizontal Scale** knob to a larger value, change the horizontal position, and then turn the **Horizontal Scale** knob back to the previous value.

Acquire. Displays the acquisition modes — Sample, Peat Detect, and Average.

Set to Zero. Sets the horizontal position to zero.

Scale. Selects the horizontal time/division (scale factor).

Trigger Controls



Trigger Menu. When it is pressed once, it displays the Trigger Menu. When it is kept pressed for more than 1.5 seconds, it will show the trigger view, meaning it will display the trigger waveform in place of the channel waveform. Use the trigger view to see how the trigger settings, such as coupling, affect the trigger signal. Releasing the button will stop the trigger view.

Level. When you use an Edge or Pulse trigger, the **Level** knob sets the amplitude level that the signal must cross to acquire a waveform. Push this knob to set the trigger level to the vertical midpoint between the peaks of the trigger signal (set to 50%).

Force Trig. Use this to complete the waveform acquisition whether or not the oscilloscope detects a trigger. This is useful for single sequence acquisitions and Normal trigger mode. (In Auto trigger mode, the oscilloscope automatically forces triggers periodically if it does not detect a trigger.)

Menu and Control Buttons



Refer to the *Reference* chapter for detailed information on the menu and button controls.

Multipurpose Knob. The function is determined by the displayed menu or selected menu option. When active, the adjacent LED lights. The next table lists the functions.

Active menu or option	Knob operation	Description
Cursor	Turn	Scroll to position the selected cursor
Help	Turn, push	Highlights entries in the Index. Highlights links in a topic. Push to select the highlighted item.
Math	Turn, push	Scroll to position and scale the Math waveform. Scroll and push to select the operation.
FFT	Turn, push	Scroll and push to select source, window type and zoom values
Measure	Turn, push	Scroll to highlight and push to select the type of automatic measurement for each source
	Turn	Scroll to position the selected gating cursors
Save/Recall	Turn, push	Scroll to highlight and push to select the action and file format. Scroll through the list of files.
Trigger	Turn, push	Scroll to highlight and push to select the trigger type, source, slope, mode, coupling, polarity, sync, video standard, trigger when operation. Turn to set the trigger holdoff and pulse width values .
Utility	Scroll, push	Scroll to highlight and push to select miscellaneous menu items. Turn to set the backlight value.
Vertical	Scroll, push	Scroll to highlight and push to select miscellaneous menu items.

Save/Recall. Displays the Save/Recall Menu for setups and waveforms.

Measure. Displays the automated measurements menu.

Acquire. Displays the Acquire Menu.

Ref. Displays the Reference Menu to quickly display and hide reference waveforms stored in the oscilloscope non-volatile memory.

Utility. Displays the Utility Menu.

Cursor. Displays the Cursor Menu. Cursors remain visible (unless the Type option is set to Off) after you leave the Cursor Menu but are not adjustable.

Help. Displays the Help Menu.

Default Setup. Recalls the factory setup.

Autoset. Automatically sets the oscilloscope controls to produce a usable display of the input signals. When held for more than 1.5 seconds, displays the Autorange Menu, and activates or deactivates the autoranging function.

Single. (Single sequence) Acquires a single waveform and then stops.

Run/Stop. Continuously acquires waveforms or stops the acquisition.

 Performs the Save function to the USB flash drive.

Save.

Input Connectors



1 & 2. Input connectors for waveform display.

Ext Trig. Input connector for an external trigger source. Use the Trigger Menu to select the Ext, or Ext/5 trigger source. Push and hold the **Trigger Menu** button to see trigger view, which will show how the trigger settings affect the trigger signal, such as trigger coupling.

PROBE COMP. Probe compensation output and chassis reference. Use to electrically match a voltage probe to the oscilloscope input circuit. (See page 6, *Manual Probe Compensation*.)

Other Front-Panel Items



USB Flash Drive port

USB Flash Drive Port. Insert a USB flash drive for data storage or retrieval.

For flash drives with an LED, the LED blinks when saving data to or retrieving data from the drive. Wait until the LED stops to remove the drive.

Understanding Oscilloscope Functions

This chapter contains general information that you need to understand before you use an oscilloscope. To use your oscilloscope effectively, you need to learn about the following functions:

- Setting up the oscilloscope
- Triggering
- Acquiring signals (waveforms)
- Scaling and positioning waveforms
- Measuring waveforms

The next figure shows a block diagram of the various functions of the oscilloscope and their relationships to each other.

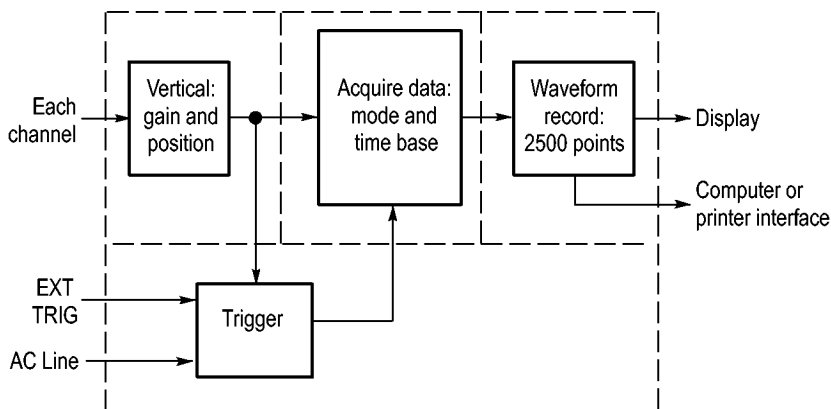

Setting Up the Oscilloscope

You should become familiar with several functions that you may use often when operating your oscilloscope: Autoset, Autorange, saving a setup, and recalling a setup.

Using Autoset

Each time you push the **Autoset** button, the Autoset function obtains a stable waveform display for you. It automatically adjusts the vertical scale, horizontal scale and trigger settings. Autoset also displays several automatic measurements in the graticule area, depending on the signal type.

Using Autorange

Autorange is a continuous function that you can enable or disable. The function adjusts setup values to track a signal when the signal exhibits large changes or when you physically move the probe to a different point. To use autorange, push the **Autoset** button for more than 1.5 seconds.

Saving a Setup

The oscilloscope saves the current setup if you wait five seconds after the last change before you power off the oscilloscope. The oscilloscope recalls this setup the next time you apply power.

You can use the Save/Recall Menu to save up to ten different setups.

You can also save setups to a USB flash drive. The oscilloscope accommodates a USB flash drive for removable data storage and retrieval. (See page 59, *USB Flash Drive Port*.)

Recalling a Setup

The oscilloscope can recall the last setup before the oscilloscope was powered off, any saved setups, or the default setup. (See page 91, *Save/Recall*.)

Default Setup

The oscilloscope is set up for normal operation when it is shipped from the factory. This is the default setup. To recall this setup, push the **Default Setup** button. To view the default settings, refer to *Appendix D: Default Setup*.

Triggering

The trigger determines when the oscilloscope starts to acquire data and to display a waveform. When a trigger is set up properly, the oscilloscope converts unstable displays or blank screens into meaningful waveforms.

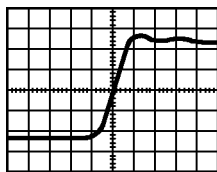

Triggered waveform

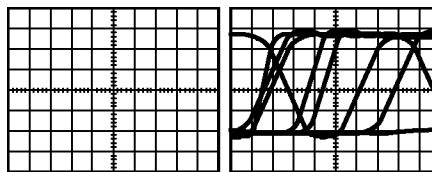

Untriggered waveforms

For oscilloscope-specific descriptions, refer to the *Operating Basics* chapter. (See page 13, *Trigger Controls*.) Refer also to the *Reference* chapter. (See page 96, *Trigger Controls*.)

When you push the **Run/Stop** or **Single** button to start an acquisition, the oscilloscope goes through the following steps:

1. Acquires enough data to fill the portion of the waveform record to the left of the trigger point. This is called the pretrigger.
2. Continues to acquire data while waiting for the trigger condition to occur.
3. Detects the trigger condition.

4. Continues to acquire data until the waveform record is full.
5. Displays the newly-acquired waveform.

NOTE. For Edge and Pulse triggers, the oscilloscope counts the rate at which trigger events occur to determine trigger frequency. The oscilloscope displays the frequency in the lower right corner of the screen.

Source You can use the Trigger Source options to select the signal that the oscilloscope uses as a trigger. The source can be the AC power line (available only with Edge triggers), or any signal connected to a channel BNC or to the Ext Trig BNC.

Types The oscilloscope provides three types of triggers: Edge, Video, and Pulse Width.

Modes You can select the Auto or the Normal trigger mode to define how the oscilloscope acquires data when it does not detect a trigger condition. (See page 97, *Mode Options*.)

To perform a single sequence acquisition, push the **Single** button.

Coupling You can use the Trigger Coupling option to determine which part of the signal will pass to the trigger circuit. This can help you attain a stable display of the waveform.

To use trigger coupling, push the **Trigger Menu** button, select an Edge or Pulse trigger, and select a Coupling option.

NOTE. Trigger coupling affects only the signal passed to the trigger system. It does not affect the bandwidth or coupling of the signal displayed on the screen.

To view the conditioned signal being passed to the trigger circuit, enable trigger view by pushing and holding down the **Trigger Menu** button for more than 1.5 seconds.

Position The horizontal position control establishes the time between the trigger and the screen center. Refer to *Horizontal Scale and Position; Pretrigger Information* for information on how to use this control to position the trigger. (See page 21, *Horizontal Scale and Position; Pretrigger Information*.)

Slope and Level

The Slope and Level controls help to define the trigger. The Slope option (Edge trigger type only) determines whether the oscilloscope finds the trigger point on the rising or the falling edge of a signal. The **Trigger Level** knob controls where on the edge the trigger point occurs.

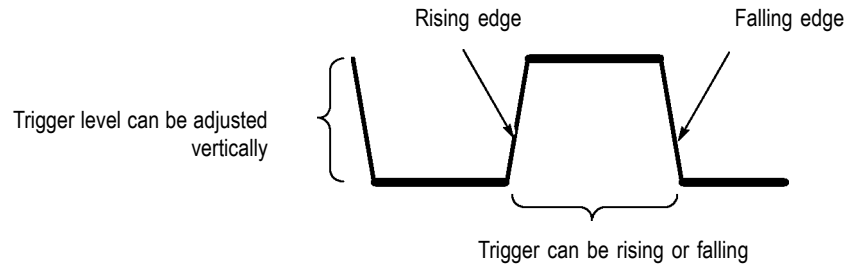

Acquiring Signals

When you acquire a signal, the oscilloscope converts it into a digital form and displays a waveform. The acquisition mode defines how the signal is digitized, and the time base setting affects the time span and level of detail in the acquisition.

Acquisition Modes

There are three acquisition modes: Sample, Peak Detect, and Average.

Sample. In this acquisition mode, the oscilloscope samples the signal in evenly spaced intervals to construct the waveform. This mode accurately represents signals most of the time.

However, this mode does not acquire rapid variations in the signal that may occur between samples. This can result in aliasing, and may cause narrow pulses to be missed. In these cases, you should use the Peak Detect mode to acquire data. (See page 22, *Time Domain Aliasing*.)

Peak Detect. In this acquisition mode, the oscilloscope finds the highest and lowest values of the input signal over each sample interval and uses these values to display the waveform. In this way, the oscilloscope can acquire and display narrow pulses, which may have otherwise been missed in Sample mode. Noise will appear to be higher in this mode.

Average. In this acquisition mode, the oscilloscope acquires several waveforms, averages them, and displays the resulting waveform. You can use this mode to reduce random noise.

Time Base

The oscilloscope digitizes waveforms by acquiring the value of an input signal at discrete points. The time base allows you to control how often the values are digitized.

To adjust the time base to a horizontal scale that suits your purpose, use the **Horizontal Scale** knob.

Scaling and Positioning Waveforms

You can change the display of waveforms by adjusting the scale and position. When you change the scale, the waveform display will increase or decrease in size. When you change the position, the waveform will move up, down, right, or left.

The channel indicator (located on the left of the graticule) identifies each waveform on the display. The indicator points to the ground reference level of the waveform record.

You can view the display area and readouts. (See page 9, *Display Area*.)

Vertical Scale and Position

You can change the vertical position of waveforms by moving them up or down in the display. To compare data, you can align a waveform above another or you can align waveforms on top of each other.

You can change the vertical scale of a waveform. The waveform display will contract or expand relative to the ground reference level.

For oscilloscope-specific descriptions, refer to the *Operating Basics* chapter. (See page 12, *Vertical Controls*.) Refer also to the *Reference* chapter. (See page 106, *Vertical Controls*.)

Horizontal Scale and Position; Pretrigger Information

You can adjust the **Horizontal Position** control to view waveform data before the trigger, after the trigger, or some of each. When you change the horizontal position of a waveform, you are actually changing the time between the trigger and the center of the display. (This appears to move the waveform to the right or left on the display.)

For example, if you want to find the cause of a glitch in your test circuit, you might trigger on the glitch and make the pretrigger period large enough to capture data before the glitch. You can then analyze the pretrigger data and perhaps find the cause of the glitch.

You change the horizontal scale of all the waveforms by turning the **Horizontal Scale** knob. For example, you might want to see just one cycle of a waveform to measure the overshoot on its rising edge.

The oscilloscope shows the horizontal scale as time per division in the scale readout. Since all active waveforms use the same time base, the oscilloscope only displays one value for all the active channels, except when you use zoom feature.

For oscilloscope-specific descriptions, refer to the *Operating Basics* chapter. (See page 13, *Position*.) Refer also to the *Reference* chapter. (See page 84, *Horizontal*.)

Time Domain Aliasing. Aliasing occurs when the oscilloscope does not sample the signal fast enough to construct an accurate waveform record. When this happens, the oscilloscope displays a waveform with a frequency lower than the actual input waveform, or triggers and displays an unstable waveform.

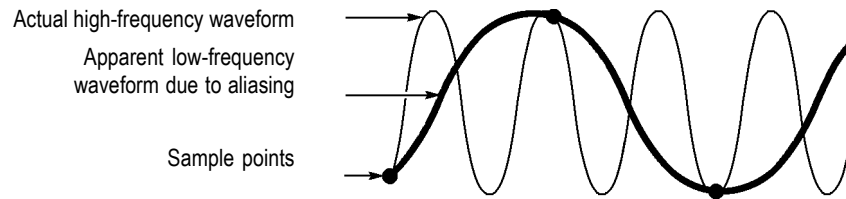

The oscilloscope accurately represents signals, but is limited by the probe bandwidth, the oscilloscope bandwidth, and the sample rate. To avoid aliasing, the oscilloscope must sample the signal more than twice as fast as the highest frequency component of the signal.

The highest frequency that the oscilloscope sampling rate can theoretically represent is the Nyquist frequency. The sample rate is called the Nyquist rate, and is twice the Nyquist frequency.

The oscilloscope maximum sample rates are at least ten times the bandwidth. These high sample rates help reduce the possibility of aliasing.

There are several ways to check for aliasing:

- Turn the horizontal **Scale** knob to change the horizontal scale. If the shape of the waveform changes drastically, you may have aliasing.
- Select the Peak Detect acquisition mode. (See page 20, *Peak Detect*.) This mode samples the highest and lowest values so that the oscilloscope can detect faster signals. If the shape of the waveform changes drastically, you may have aliasing.
- If the trigger frequency is faster than the display information, you may have aliasing or a waveform that crosses the trigger level multiple times. Examining the waveform allows you to identify whether the shape of the signal is going to allow a single trigger crossing per cycle at the selected trigger level.

If multiple triggers are likely to occur, select a trigger level that will generate only a single trigger per cycle. If the trigger frequency is still faster than the display indicates, you may have aliasing.

If the trigger frequency is slower, this test is not useful.

- If the signal you are viewing is also the trigger source, use the graticule or the cursors to estimate the frequency of the displayed waveform. Compare this to the Trigger Frequency readout in the lower right corner of the screen. If they differ by a large amount, you may have aliasing.

Taking Measurements

The oscilloscope displays graphs of voltage versus time and can help you to measure the displayed waveform.

There are several ways to take measurements. You can use the graticule, the cursors, or an automated measurement.

Graticule This method allows you to make a quick, visual estimate. For example, you might look at a waveform amplitude and determine that it is a little more than 100 mV.

You can take simple measurements by counting the major and minor graticule divisions involved and multiplying by the scale factor.

For example, if you counted five major vertical graticule divisions between the minimum and maximum values of a waveform and knew you had a scale factor of 100 mV/division, then you could calculate your peak-to-peak voltage as follows:

$$5 \text{ divisions} \times 100 \text{ mV/division} = 500 \text{ mV}$$

Cursor

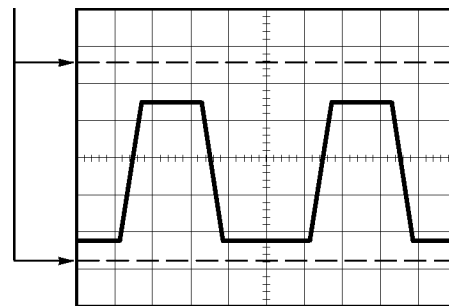

Cursors This method allows you to take measurements by moving the cursors, which always appear in pairs, and reading their numeric values from the display readouts. There are two types of cursors: Amplitude and Time.

When you use cursors, be sure to set **Source** to the waveform on the display that you want to measure.

You can use the cursors to define the measurement gating area, after you have turned on **Measure Gating** in the **Measure** menu. The oscilloscope will restrict the gated measurement you take to the data between the two cursors.

To use cursors, push the **Cursor** button.

Amplitude Cursors. Amplitude cursors appear as horizontal lines on the display and measure the vertical parameters. Amplitudes are referenced to the reference level. For the FFT function, these cursors measure magnitude.

Time Cursors. Time cursors appear as vertical lines on the display and measure both horizontal and vertical parameters. Times are referenced to the trigger point. For the FFT function, these cursors measure frequency.

Time cursors also include a readout of the waveform amplitude at the point the waveform crosses the cursor.

Automatic

The Measure Menu can take up to six automatic measurements. When you take automatic measurements, the oscilloscope does all the calculating for you. Because the measurements use the waveform record points, they are more accurate than the graticule or cursor measurements.

Automatic measurements use readouts to show measurement results. These readouts are updated periodically as the oscilloscope acquires new data.

For measurement descriptions, refer to the *Reference* chapter. (See page 85, *Taking Measurements*.)

Application Examples

This section presents a series of application examples. These simplified examples highlight the features of the oscilloscope and give you ideas for using it to solve your own test problems.

- Taking simple measurements

 - Using Autoset

 - Using the Measure Menu to take automatic measurements

 - Measuring two signals and calculating gain

- Using Autorange to examine a series of test points

- Taking cursor measurements

 - Measuring ring frequency and ring amplitude

 - Measuring pulse width

 - Measuring rise time

- Analyzing signal detail

 - Looking at a noisy signal

 - Using the average function to separate a signal from noise

- Capturing a single-shot signal

 - Optimizing the acquisition

- Measuring propagation delay

- Triggering on a pulse width

- Triggering on a video signal

 - Triggering on video fields and video lines

 - Using the window function to see waveform details

- Analyzing a differential communication signal using Math functions

- Viewing impedance changes in a network using XY mode and persistence

- Data logging (non-EDU models only)

- Limit testing (non-EDU models only)

Taking Simple Measurements

You need to see a signal in a circuit, but you do not know the amplitude or frequency of the signal. You want to quickly display the signal and measure the frequency, period, and peak-to-peak amplitude.

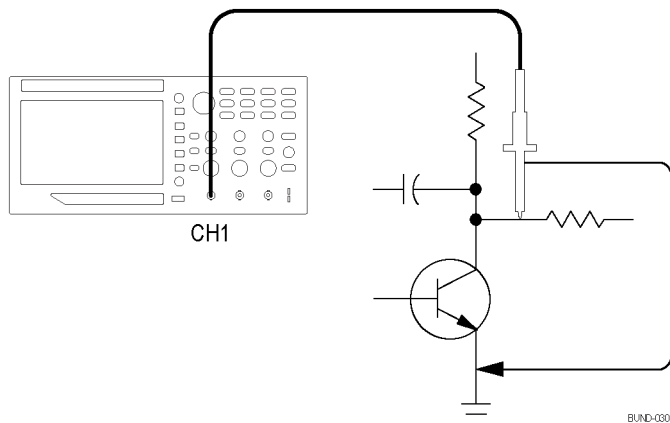

Using Autoset

To quickly display a signal, follow these steps:

1. Push the **1** (channel 1 menu) button.
2. Push **Probe** ► **Voltage** ► **Attenuation** ► **10X**.
3. If using P2220 probes, set their switches to **10X**.
4. Connect the channel 1 probe tip to the signal. Connect the reference lead to the circuit reference point.
5. Push the **Autoset** button.

The oscilloscope sets the vertical, horizontal, and trigger controls automatically. If you want to optimize the display of the waveform, you can manually adjust these controls.

NOTE. *The oscilloscope displays relevant automatic measurements in the waveform area of the screen based on the signal type that is detected.*

For oscilloscope-specific descriptions, refer to the *Reference* chapter. (See page 73, *Autoset*.)

Taking Automatic Measurements

The oscilloscope can take automatic measurements of most displayed signals.

NOTE. *If a question mark (?) appears in the Value readout, the signal is outside the measurement range. Adjust the **Vertical Scale** knob (volts/division) of the appropriate channel to decrease the sensitivity or change the horizontal **Scale** setting (seconds/division).*

To measure signal frequency, period, and peak-to-peak amplitude, rise time, and positive width, follow these steps:

1. Push the **Measure** button to see the Measure Menu.
2. Push the channel **1** or the **2** button. The measure menu appears to the left.
3. Turn the **Multipurpose** knob to highlight the desired measurement. Push the knob to select the desired measurement. .

The **Value** readout displays the measurement and updates.

4. Push the channel **1** or **2** button to select another measurement. You can display up to six measurements on the screen at a time.

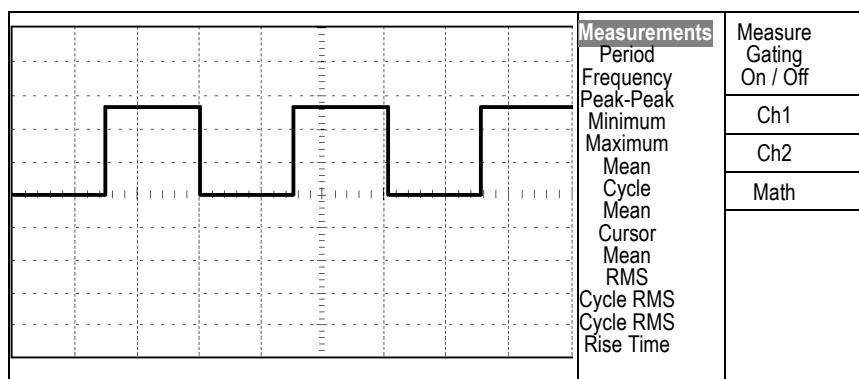

Measuring Two Signals

If you are testing a piece of equipment and need to measure the gain of the audio amplifier, you will need an audio generator that can inject a test signal at the amplifier input. Connect two oscilloscope channels to the amplifier input and output as shown next. Measure both signal levels and use the measurements to calculate the gain.

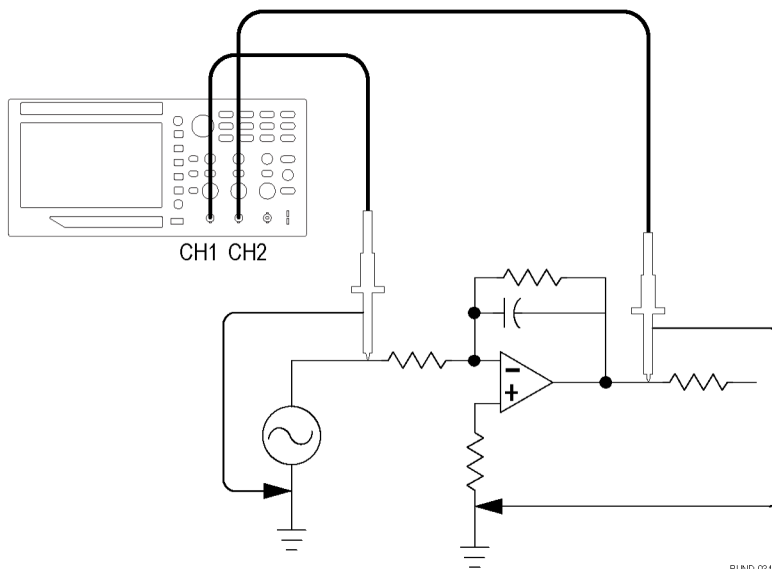

BUND-031

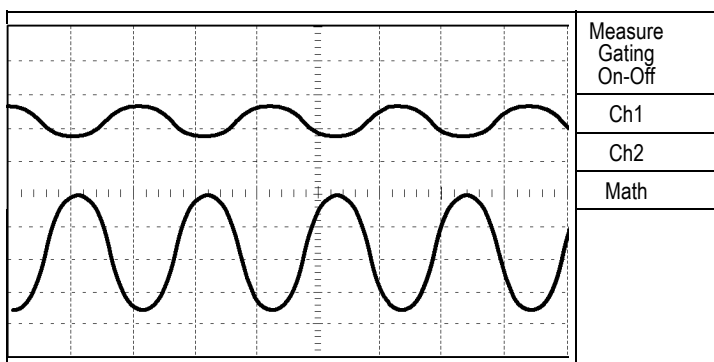

To activate and display the signals connected to channel 1 and to channel 2, and select measurements for the two channels, follow these steps:

1. Push the **Autoset** button.
2. Push the **Measure** button to see the Measure Menu.
3. Push the **Ch1** side menu. The pop-up menu of measurement types appears to the left.
4. Turn the **Multipurpose** knob to highlight **Peak-Peak**.
5. Push the **Multipurpose** knob to select **Peak-Peak**. A check should appear next to the menu item and the Peak-to-Peak measurement for channel 1 should appear towards the bottom of the display.

6. Push the **Ch1** side menu. The pop-up menu of measurement types appears to the left. .
7. Turn the **Multipurpose** knob to highlight **Peak-Peak**.
8. Push the **Multipurpose** knob to select **Peak-Peak**. A check should appear next to the menu item and the peak-to-peak for channel 2 should appear towards the bottom of the display.
9. Read the displayed peak-to-peak amplitudes for both channels.
10. To calculate the amplifier voltage gain, use these equations:

$$\textit{VoltageGain} = \textit{output amplitude}/\textit{input amplitude}$$

$$\textit{VoltageGain (dB)} = 20 \times \log_{10} (\textit{VoltageGain})$$

Using Autorange to Examine a Series of Test Points

If you have a machine that is malfunctioning, you may need to find the frequency and RMS voltage of several test points, and compare these values to ideal values. You are not able to access front-panel controls since you need to use both hands when probing test points that are difficult to physically reach.

1. Push the **1** (channel 1 menu) button.
2. Push **Probe ► Voltage ► Attenuation**. Chose the attenuation of the probe attached to channel 1 from the pop-out selectable list of values by turning and pushing the **Multipurpose** knob.
3. Push the **Autoset** button for more than 1.5 seconds to activate autoranging, and select the **Vertical and Horizontal** option.
4. Push the **Measure** button to see the Measure Menu.
5. Push **Ch1**.
6. Turn the **Multipurpose** knob to select **Frequency**.
7. Push **Ch2**.
8. Turn the **Multipurpose** knob to select **Cycle RMS**.
9. Attach the probe tip and reference lead to the first test point. Read the frequency and cycle RMS measurements from the oscilloscope display and compare these to the ideal values.
10. Repeat the preceding step for each test point, until you find the malfunctioning component.

NOTE. When Autorange is active, each time you move the probe to another test point, the oscilloscope readjusts the horizontal scale, the vertical scale, and the trigger level, to give you a useful display.

Taking Cursor Measurements

You can use the cursors to quickly take time and amplitude measurements on a waveform.

Measuring Ring Frequency and Amplitude

To measure the ring frequency at the rising edge of a signal, follow these steps:

1. Push the **Cursor** front-panel button to see the Cursor Menu.
2. Push the **Type** side-menu button. A pop-out menu should appear showing a scroll-able list of the available cursor types.
3. Turn the **Multipurpose** knob to highlight **Time**.
4. Push the **Multipurpose** knob to select **Time**.

5. Push the **Source** side-menu button. A pop-out menu should appear showing a scroll-able list of the available sources.
6. Turn the **Multipurpose** knob to highlight **Ch1**.
7. Push the **Multipurpose** knob to select **Ch1**.
8. Push the **Cursor 1** option button.
9. Turn the multipurpose knob to place a cursor on the first peak of the ring.
10. Push the **Cursor 2** option button.
11. Turn the multipurpose knob to place a cursor on the second peak of the ring.

You can see the Δ (delta) time and frequency (the measured ring frequency) in the Cursor Menu.

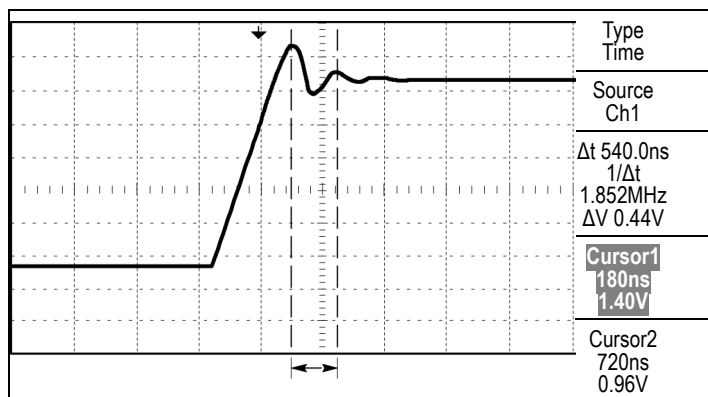

12. Push the **Type** side-menu button. A pop-out menu should appear showing a scroll-able list of the available cursor types.
13. Turn the **Multipurpose** knob to highlight **Amplitude**.
14. Push the **Multipurpose** knob to select **Amplitude**.
15. Push the **Cursor 1** option button.
16. Turn the multipurpose knob to place a cursor on the first peak of the ring.
17. Push the **Cursor 2** option button.
18. Turn the multipurpose knob to place Cursor 2 on the lowest part of the ring.

You can see the amplitude of the ring in the Cursor Menu.

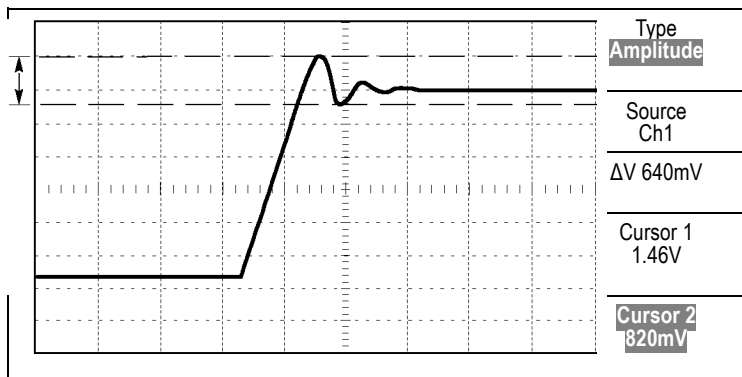

Measuring Pulse Width

If you are analyzing a pulse waveform and you want to know the width of the pulse, follow these steps:

1. Push the **Cursor** button to see the Cursor Menu.
2. Push the **Type** side-menu button. A pop-out menu should appear showing a scroll-able list of the available cursor types.
3. Turn the **Multipurpose** knob to highlight **Time**.
4. Push the **Multipurpose** knob to select **Time**.
5. Push the **Cursor 1** option button.
6. Turn the multipurpose knob to place a cursor on the rising edge of the pulse.
7. Push the **Cursor 2** option button.
8. Turn the multipurpose knob to place a cursor on the falling edge of the pulse.

You can see the following measurements in the Cursor Menu:

- The time at Cursor 1, relative to the trigger.
- The time at Cursor 2, relative to the trigger.
- The Δ (delta) time, which is the pulse width measurement.

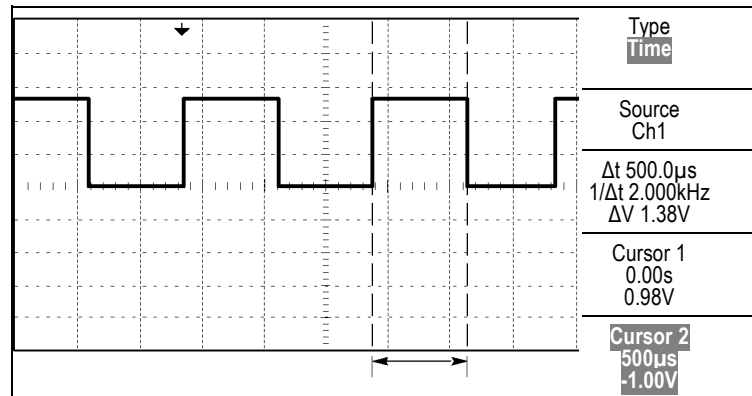

NOTE. The Positive Width measurement is available as an automatic measurement in the Measure Menu. (See page 85, Taking Measurements.)

NOTE. The Positive Width measurement also displays when you select the Single-Cycle Square option in the Autoset Menu. (See page 75, Square Wave or Pulse.)

Measuring Rise Time

After measuring the pulse width, you decide that you need to check the rise time of the pulse. Typically, you measure rise time between the 10% and 90% levels of the waveform. To measure the rise time, follow these steps:

1. Turn the **Horizontal Scale** (seconds/division) knob to display the rising edge of the waveform.
2. Turn the **Vertical Scale** (volts/division) and **Vertical Position** knobs to set the waveform amplitude to about five divisions.
3. Push the **1** (channel 1 menu) button.
4. Push **Volts/Div ► Fine**.
5. Turn the **Vertical Scale** (volts/division) knob to set the waveform amplitude to exactly five divisions.
6. Turn the **Vertical Position** knob to center the waveform; position the baseline of the waveform 2.5 divisions below the center graticule.
7. Push the **Cursor** button to see the Cursor Menu.
8. Push the **Type** side-menu button. A pop-out menu should appear showing a scroll-able list of the available cursor types.
9. Turn the **Multipurpose** knob to highlight **Time**.
10. Push the **Multipurpose** knob to select **Time**.

11. Push the **Source** side-menu button. A pop-out menu should appear showing a scroll-able list of the available sources.
12. Turn the **Multipurpose** knob to highlight **Ch1**.
13. Push the **Multipurpose** knob to select **Ch1**.
14. Push the **Cursor 1** option button.
15. Turn the multipurpose knob to place a cursor at the point where the waveform crosses the second graticule line below center screen. This is the 10% level of the waveform.
16. Push the **Cursor 2** option button.
17. Turn the multipurpose knob to place a cursor at the point where the waveform crosses the second graticule line above center screen. This is the 90% level of the waveform.

The Δt readout in the Cursor Menu is the rise time of the waveform.

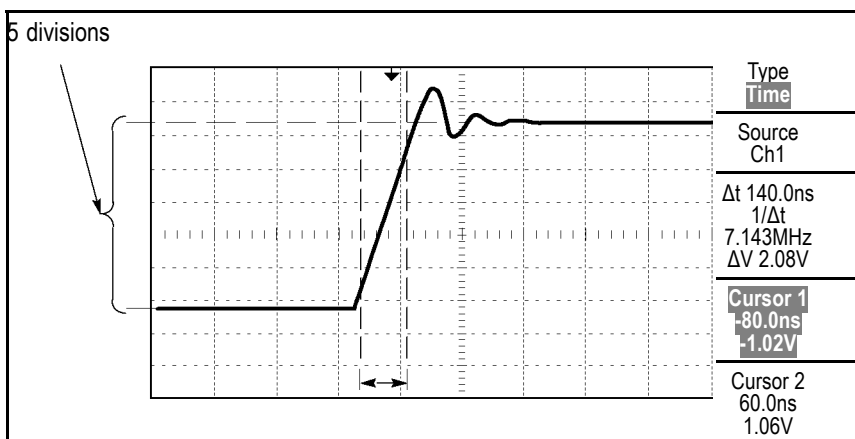

NOTE. The Rise Time measurement is available as an automatic measurement in the Measure Menu. (See page 85, Taking Measurements.)

NOTE. The Rise Time measurement also displays when you select the Rising Edge option in the Autoset Menu. (See page 75, Square Wave or Pulse.)

Analyzing Signal Detail

You have a noisy signal displayed on the oscilloscope and you need to know more about it. You suspect that the signal contains much more detail than you can now see in the display.

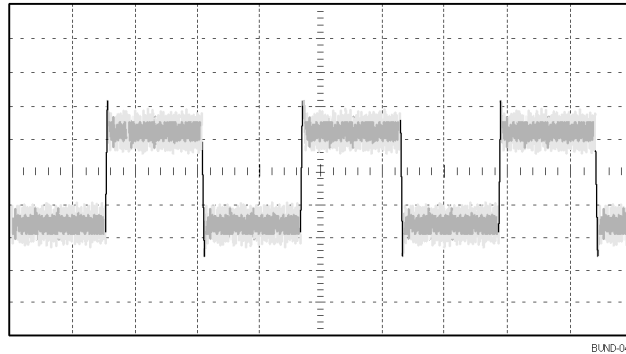

Looking at a Noisy Signal

The signal appears noisy and you suspect that noise is causing problems in your circuit. To better analyze the noise, follow these steps:

1. Push the **Acquire** button to see the Acquire Menu.
2. Push the **Peak Detect** option button.

Peak detect emphasizes noise spikes and glitches in your signal, especially when the time base is set to a slow setting.

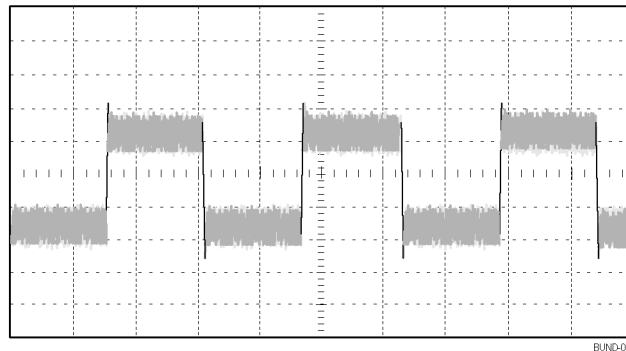

Separating the Signal from Noise

Now you want to analyze the signal shape and ignore the noise. To reduce random noise in the oscilloscope display, follow these steps:

1. Push the **Acquire** button to see the Acquire Menu.
2. Push the **Average** option button.
3. Turn the **Multipurpose** knob to highlight different numbers of averages from the pop-up menu. As you push the knob to select a different number, you can

see the effects of varying the number of running averages on the waveform display.

Averaging reduces random noise and makes it easier to see detail in a signal. In the example below, a ring shows on the rising and falling edges of the signal when the noise is removed.

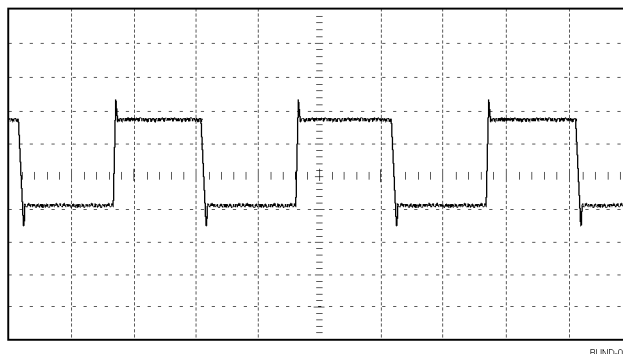

Capturing a Single-Shot Signal

The reliability of a reed relay in a piece of equipment has been poor and you need to investigate the problem. You suspect that the relay contacts arc when the relay opens. The fastest that you can open and close the relay is about once per minute, so you need to capture the voltage across the relay as a single-shot acquisition.

To set up for a single-shot acquisition, follow these steps:

1. Turn the **Vertical Scale** (volts/division) and **Horizontal Scale** (seconds/division) knobs to the appropriate ranges for the signal you expect to see.
2. Push the **Acquire** button to see the Acquire Menu.
3. Push the **Peak Detect** option button.
4. Push the **Trigger Menu** button to see the Trigger Menu.
5. Push **Slope**.
6. Turn the **Multipurpose** knob to highlight **Rising** from the pop-out menu. Push the knob to select the choice.
7. Turn the front-panel **Level** knob to adjust the trigger level to a voltage midway between the open and closed voltages of the relay.
8. Push the **Single** button to start the acquisition.

When the relay opens, the oscilloscope triggers and captures the event.

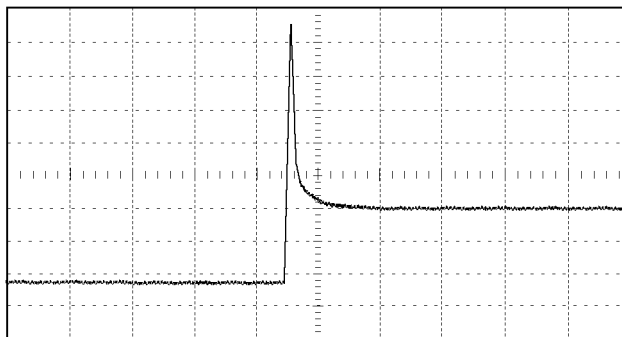

Optimizing the Acquisition

The initial acquisition shows the relay contact beginning to open at the trigger point. This is followed by a large spike that indicates contact bounce and inductance in the circuit. The inductance can cause contact arcing and premature relay failure.

You can use the vertical, horizontal, and trigger controls to optimize the settings before the next single-shot event is captured. When the next acquisition is captured with the new settings (push the **Single** button again), you can see that the contact bounces several times as it opens.

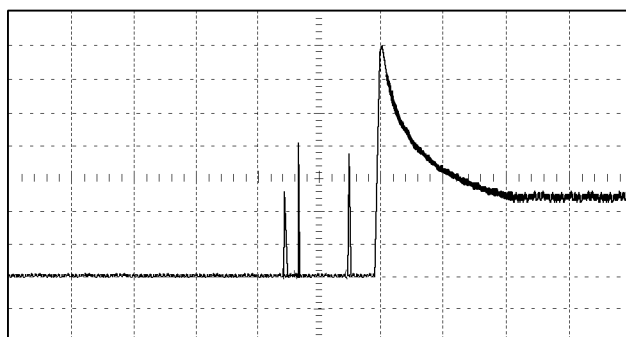

Measuring Propagation Delay

You suspect that the memory timing in a microprocessor circuit is marginal. Set up the oscilloscope to measure the propagation delay between the chip-select signal and the data output of the memory device.

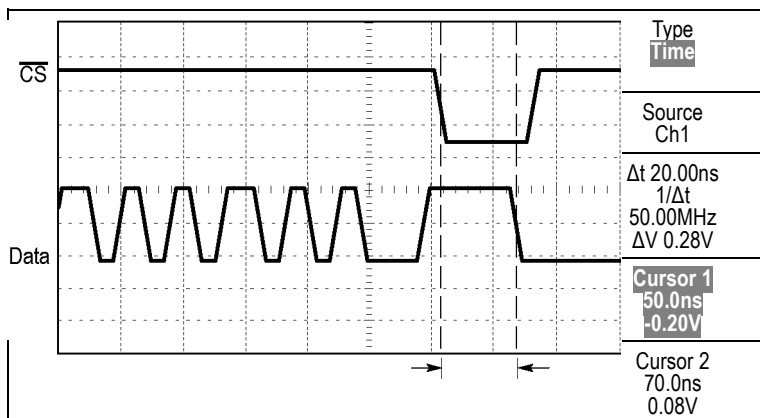
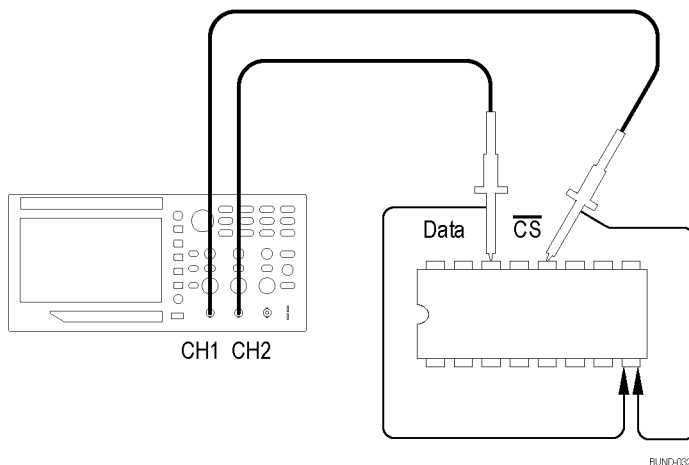

To set up to measure propagation delay, follow these steps:

1. Push the **Autoset** button to trigger a stable display.
2. Adjust the horizontal and vertical controls to optimize the display.
3. Push the **Cursor** button to see the Cursor Menu.
4. Push the **Type** side-menu button. A pop-out menu should appear showing a scroll-able list of the available cursor types.
5. Turn the **Multipurpose** knob to highlight **Time**.
6. Push the **Multipurpose** knob to select **Time**.
7. Push the **Source** side-menu button. A pop-out menu should appear showing a scroll-able list of the available sources.

8. Turn the **Multipurpose** knob to highlight **Ch1**.
9. Push the **Multipurpose** knob to select **Ch1**.
10. Push the **Cursor 1** option button.
11. Push the **Cursor 1** option button.
12. Turn the multipurpose knob to place a cursor on the active edge of the chip-select signal.
13. Push the **Cursor 2** option button.
14. Turn the multipurpose knob to place the second cursor on the data output transition.

The Δt readout in the Cursor Menu is the propagation delay between the waveforms. The readout is valid because the two waveforms have the same horizontal scale (seconds/division) setting.

Triggering on a Specific Pulse Width

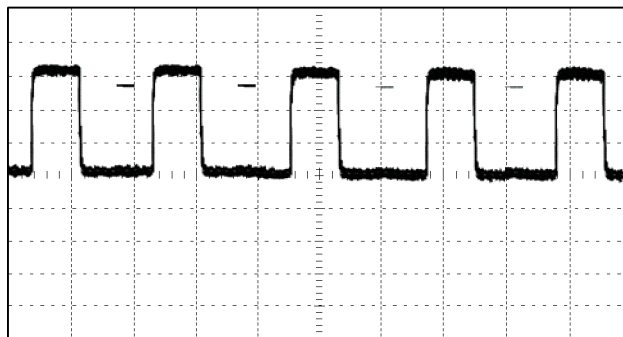

BUND-051

To set up a test for pulse width aberrations, follow these steps:

1. Push the **Autoset** button to trigger a stable display.
2. Push the single cycle  option button in the Autoset Menu to view a single cycle of the signal, and to quickly take a Pulse Width measurement.
3. Push the **Trigger Menu** button to see the Trigger Menu.
4. Push **Type**.
5. Turn the **Multipurpose** knob to highlight **Pulse** from the pop-out menu. Push the knob to select the choice.
6. Push **Source**.
7. Turn the **Multipurpose** knob to highlight **Ch1** from the pop-out menu. Push the knob to select the choice.

8. Turn the trigger **Level** knob to set the trigger level near the bottom of the signal.
9. Push **When** ► = (equals).
10. Push **Pulse Width**.
11. Turn the multipurpose knob to set the pulse width to the value reported by the Pulse Width measurement in step 2.
12. Push **More** ► **Mode** ► **Normal**.

You can achieve a stable display with the oscilloscope triggering on normal pulses.

1. Push the **When** option button to select \neq , $<$, or $>$. If there are any aberrant pulses that meet the specified When condition, the oscilloscope triggers.



NOTE. The trigger frequency readout shows the frequency of events that the oscilloscope might consider to be a trigger, and may be less than the frequency of the input signal in Pulse Width trigger mode.

Triggering on a Video Signal

You are testing the video circuit in a piece of medical equipment and need to display the video output signal. The video output is an NTSC standard signal. Use the video trigger to obtain a stable display.

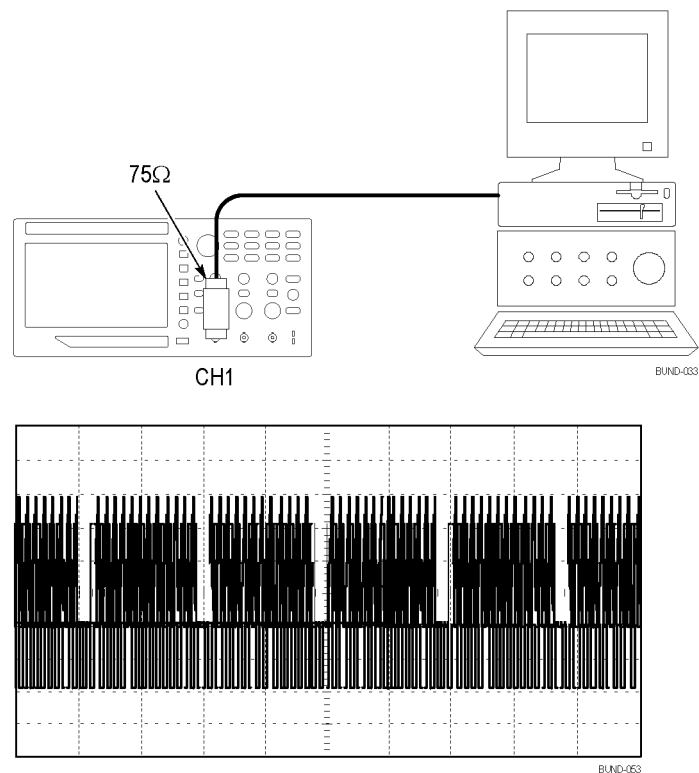

NOTE. Most video systems use 75 ohm cabling. The oscilloscope inputs do not properly terminate low impedance cabling. To avoid amplitude inaccuracy from improper loading and reflections, place a 75 ohm feedthrough terminator (Tektronix part number 011-0055-02 or equivalent) between the 75 ohm coaxial cable from the signal source and the oscilloscope BNC input.

Triggering on Video Fields

Automatic. To trigger on the video fields, follow these steps:

1. Push the **Autoset** button. When Autoset is complete, the oscilloscope displays the video signal with sync on **All Fields**.

The oscilloscope sets the Standard option when you use the Autoset function.

1. Push the **Odd Field** or **Even Field** option buttons from the **Autoset** Menu to sync on odd or even fields only.

Manual. An alternative method requires more steps, but may be necessary depending on the video signal. To use the manual method, follow these steps:

1. Push the **1** (channel 1 menu) button.
2. Push **Coupling ► AC**.
3. Push the **Trigger Menu** button to see the Trigger Menu.
4. Push the top option button and select **Video**.
5. Push **Source ► Ch1**.
6. Push the **Sync** option button and select **All Fields**, **Odd Field**, or **Even Field**.
7. On page 2 of the side menu, push **Standard ► NTSC**.
8. Turn the **Horizontal Scale** (seconds/division) knob to see a complete field across the screen.
9. Turn the **Vertical Scale** (volts/division) knob to ensure that the entire video signal is visible on the screen.

Triggering on Video Lines

Automatic. You can also look at the video lines in the field. To trigger on the video lines, follow these steps:

1. Push the **Autoset** button.
2. Push the top option button to select **Line** to sync on all lines. (The Autoset Menu includes **All Lines** and **Line Number** options.)

Manual. An alternative method requires more steps, but may be necessary depending on the video signal. To use this method, follow these steps:

1. Push the **Trigger Menu** button to see the Trigger Menu.
2. Push the top option button and select **Video**.
3. Push the **Sync** option button and select **All Lines** or **Line Number** and turn the multipurpose knob to set a specific line number.
4. Push **Standard** ► **NTSC**.
5. Turn the **Horizontal Scale** (seconds/division) knob to see a complete video line across the screen.
6. Turn the **Vertical Scale** (volts/division) knob to ensure that the entire video signal is visible on the screen.

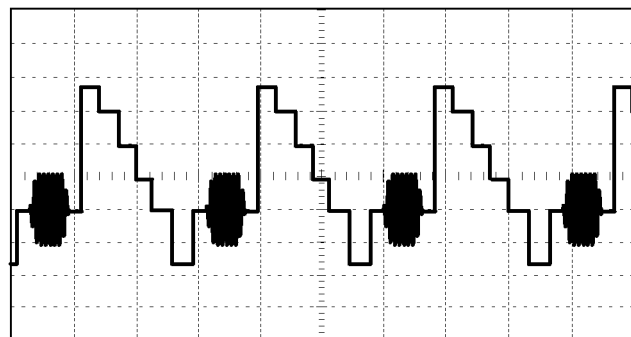
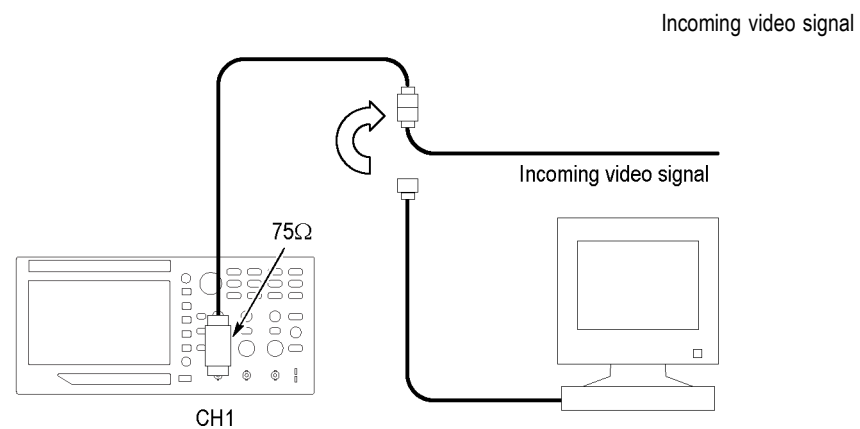

BUND-034

Using the Zoom Function to See Waveform Details

You can use the zoom function to examine a specific portion of a waveform without changing the main display.

If you want to view the color burst in the previous waveform in more detail without changing the main display, follow these steps:

1. Push the **Zoom** front-panel button.

When pressing the **Zoom** button, the waveform display area will show original waveform (about 1/4) and zoom in waveform (about 3/4). And the menu area will keep the original menu. If both channels are turned on at the same time, there will be two zoom in waveforms at the top window.

2. Push the **Scale** side-menu button and turn the **Multipurpose** knob to change the zoom scale.
3. Push the **Position** side-menu button and turn the **Multipurpose** knob to change the zoom position.
4. Turn the horizontal **Scale** (seconds/division) knob and select 500 ns. This will be the seconds/division setting of the expanded view.
5. Turn the horizontal **Position** knob to position the zoom window around the portion of the waveform that you want to expand.

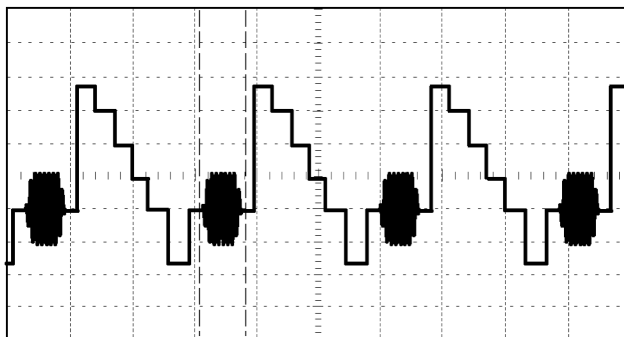

BUND-054

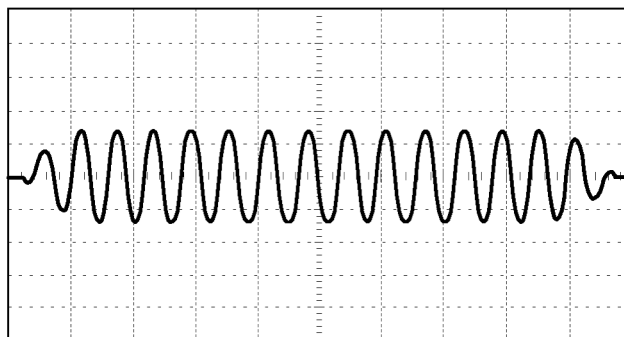

BUND-055

Analyzing a Differential Communication Signal

You are having intermittent problems with a serial data communication link, and you suspect poor signal quality. Set up the oscilloscope to show you a snapshot of the serial data stream so you can verify the signal levels and transition times.

Because this is a differential signal, you use the Math function of the oscilloscope to view a better representation of the waveform.

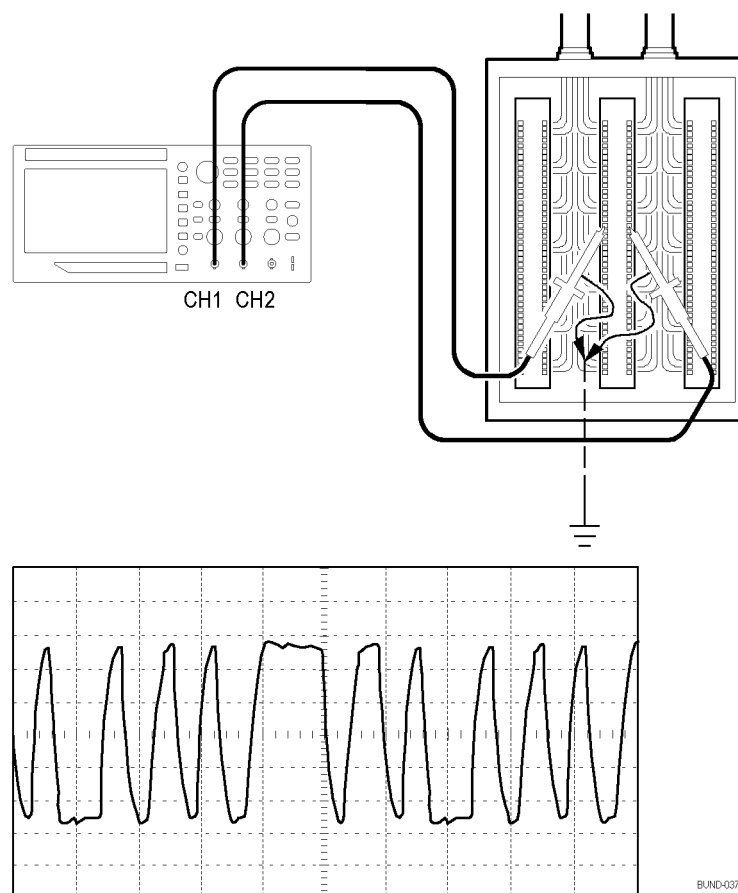

NOTE. Be sure to first compensate both probes. Differences in probe compensation appear as errors in the differential signal.

To activate the differential signals connected to channel 1 and to channel 2, follow these steps:

1. Push the **1** (channel 1 menu) button and set the **Probe ▶ Voltage ▶ Attenuation** option to **10X**.
2. Push the **2** (channel 2 menu) button and set the **Probe ▶ Voltage ▶ Attenuation** option to **10X**.

3. If using P2220 probes, set their switches to 10X.
4. Push the **Autoset** button.
5. Push the **Math** button to see the Math Menu.
6. Push the **Operation** option button and select -.
7. Push the **Sources Ch1-Ch2** option button to display a new waveform that is the difference between the displayed waveforms.
8. To adjust the vertical scale and position of the Math waveform, follow these steps:
 - a. Remove the channel 1 and channel 2 waveforms from the display.
 - b. Turn the channel 1 and channel 2 **Vertical Scale** and **Vertical Position** knobs to adjust the vertical scale and position of the Math waveform.

For a more stable display, push the **Single** button to control the acquisition of the waveform. Each time you push the **Single** button, the oscilloscope acquires a snapshot of the digital data stream. You can use the cursors or automatic measurements to analyze the waveform, or you can store the waveform to analyze later.

Viewing Impedance Changes in a Network

You have designed a circuit that needs to operate over a wide temperature range. You need to evaluate the change in impedance of the circuit as the ambient temperature is changed.

Connect the oscilloscope to monitor the input and output of the circuit and capture the changes that occur as you vary the temperature.

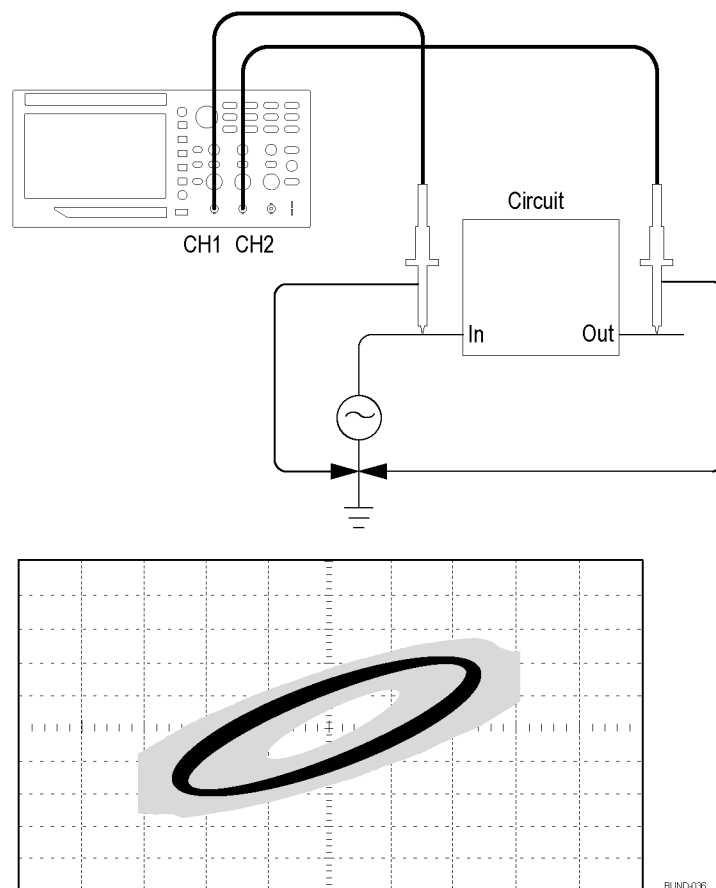

To view the input and output of the circuit in an XY display, follow these steps:

1. Push the **1** (channel 1 menu) button.
2. Push **Probe** ► **Voltage** ► **Attenuation** ► **10X**.
3. Push the **2** (channel 2 menu) button.
4. Push **Probe** ► **Voltage** ► **Attenuation** ► **10X**.
5. If using P2220 probes, set their switches to **10X**.
6. Connect the channel 1 probe to the input of the network, and connect the channel 2 probe to the output.
7. Push the **Autoset** button.
8. Turn the **Vertical Scale** (volts/division) knobs to display approximately the same amplitude signals on each channel.
9. Push the **Utility** ► **Display** button to see the Display Menu.
10. Push **Format** ► **XY**.

The oscilloscope displays a Lissajous pattern representing the input and output characteristics of the circuit.

11. Turn the vertical **Scale** and vertical **Position** knobs to optimize the display.
12. Push **Persist ► Infinite**.

As you adjust the ambient temperature, the display persistence captures the changes in the characteristics of the circuit.

Data Logging (non-EDU models only)

You can use the oscilloscope to record data from a source over time. You can configure the trigger conditions and direct the oscilloscope to save all the triggered waveform together with timing information over a defined time duration to a USB memory device.

The USB host port on the front panel supports data logging. You can set up the oscilloscope to save user- specified triggered waveforms to a USB device for up to 24 hours. You can also select the "Infinite" option for continuous waveform monitoring. In the infinite mode you can save your triggered waveforms to an external USB memory device without a duration limitation until the memory device is full. The oscilloscope will then guide you to insert another USB memory device to continue saving waveforms.

1. Configure the oscilloscope to use the desired trigger conditions to collect the data. Also, insert a USB memory device in the front-panel USB port.
2. Push the front-panel **Function** button.
3. Select **Data Logging** from the resulting side menu to bring up the data logging menu.
4. Push **Data Logging** from the side menu to select **On**. This enables the data logging feature. Before turning on the data logging feature, you must first select the source, the time duration, and the folder.
5. Push the **Source** button to select the signal source to log data from. You can use either one of the input channels or the Math waveform.
6. Push the **Duration** button as many times as needed or use the multipurpose knob to select the duration for data logging. The selections range from 0.5 hour to 8 hours in 30 minute increments and from 8 hours to 24 hours in 60 minute increments. You can select **Infinite** to run data logging with no set time limit.
7. Push the **Select Folder** button to define where to store the collected information. The resulting menu choices will let you either select an existing folder or define a new folder. When done, push **Back** to return to the main data logging menu

8. Start the data acquisition, such as by pushing either the front-panel **Single** or **Run/Stop** button.
9. When the oscilloscope finishes the requested data logging operation, it displays a “Data logging completed” message and turns off the data logging feature.

Limit Testing (non-EDU models only)

You can use the oscilloscope to monitor an active input signal against a template and to output pass or fail results by judging whether the input signal is within the bounds of the template.

Use the limit test if you need a Pass/Fail test to determine if a signal is good. Set up the oscilloscope to automatically monitor a source signals and output Pass or Fail results by evaluating whether or not the acquired waveform falls within predefined boundaries. The limit test feature allows you to create templates based on one or two independent reference waveforms. If a failure is detected, a series of specific actions can be triggered.

1. Push the front-panel **Function** button.
2. Select **Limit Test** from the resulting side menu to bring up the limit testing menu.
3. Select **Source** from the side menu to define the source of the waveform to compare against the limit test template.
4. Select **Compare To** to specify the limit test template against which to compare test signals sectioned with the **Source** menu item.
5. Push **Template Setup** from the side menu to define the boundary to compare with the input source signals. You can create the template with specific horizontal and vertical tolerances. You can create them from channel 1, channel 2, or the Math waveform.
6. Push **Display Template** and toggle between **On** and **Off** to display or not a stored template.
7. Push the **Action on Violation** button and select an action from the resulting menu to describe what the oscilloscope will do after it detects a violation. You can select between **Save Waveform** and **Save Image**.
8. Push the **Stop After** button and toggle the resulting button with the same name to define the conditions that will stop limit testing. Select **Waveforms**, **Violations**, or **Time** and use the multipurpose knob to set the desired number of waveforms, number of violations, or the time in seconds at which to stop. You can also choose to stop the testing manually.
9. Push the **Run/Stop Test** button to toggle between starting and ending the limit test. After you end the test, the oscilloscope will display the test statistics on

the screen. This includes the number of cases tested, the number of cases passed, and the number of cases failed.

FFT

FFT converts a time-domain (YT) signal into its frequency components (spectrum). The oscilloscope can optionally display the source waveform at the same time as the FFT waveform. Use FFT for the following types of analysis:

- Analyze harmonics in power lines
- Measure harmonic content and distortion in systems
- Characterize noise in DC power supplies
- Test impulse response of filters and systems
- Analyze vibration

To use FFT, you need to perform the following tasks:

- Set up the source (time-domain) waveform
- Display the FFT spectrum
- Select a type of FFT window
- Adjust the sample rate to display the fundamental frequency and harmonics without aliasing
- Use cursors to measure the spectrum

Setting Up the Time-Domain Waveform

Before you use FFT, you need to set up the time-domain (YT) waveform. To do so, follow these steps:

1. Push **Autoset** to display a YT waveform.
2. Turn the vertical **Position** knob to move the YT waveform to the center vertically (zero divisions).

This ensures that the FFT will show a true DC value.

3. Turn the **Horizontal Position** knob to position the part of the YT waveform that you want to analyze in the center eight divisions of the screen.

The oscilloscope calculates the FFT spectrum using the center 2048 points of the time-domain waveform.

4. Turn the **Vertical Scale** (volts/division) knob to ensure that the entire waveform remains on the screen. The oscilloscope may display erroneous FFT results (by adding high frequency components) if the entire waveform is not visible.
5. Turn the **Horizontal Scale** (seconds/division) knob to provide the resolution you want in the FFT spectrum.
6. If possible, set the oscilloscope to display many signal cycles.

If you turn the horizontal **Scale** knob to select a faster setting (fewer cycles), the FFT spectrum shows a larger frequency range, and reduces the possibility of FFT aliasing. (See page 55, *FFT Aliasing*.) However, the oscilloscope also displays less frequency resolution.

To set up the FFT display, follow these steps:

1. Push the **FFT** front-panel button to see the FFT side menu.
2. Push **Source** from the side menu.
3. Turn the **Multipurpose** knob to highlight the source channel. Push the knob to select the channel.

In many cases, the oscilloscope can produce a useful FFT spectrum even if the YT waveform is not triggered. This is especially true if your signal is periodic or random (noisy).

NOTE. *Trigger and position any transient or burst waveforms as closely as possible to the center of the screen.*

Nyquist Frequency

The highest frequency that any real-time digitizing oscilloscope can measure without errors is one-half the sample rate. This frequency is called the Nyquist frequency. Frequency information above the Nyquist frequency is undersampled, which causes FFT aliasing. (See page 55, *FFT Aliasing*.)

The math function transforms the center 2048 points of the time-domain waveform into an FFT spectrum. The resulting FFT spectrum contains 1024 points that go from DC (0 Hz) to the Nyquist frequency.

Normally, the display compresses the FFT spectrum horizontally into 250 points, but you can use the FFT Zoom function to expand the FFT spectrum to more clearly see the frequency components at each of the 1024 data points in the FFT spectrum.

NOTE. *The oscilloscope vertical response rolls off slowly above its bandwidth (40 MHz, 60 MHz, 100 MHz or 200 MHz, depending on the model, or 20 MHz when the Bandwidth Limit option is ON). Therefore, the FFT spectrum can show valid frequency information higher than the oscilloscope bandwidth. However, the magnitude information near or above the bandwidth will not be accurate.*

Displaying the FFT Spectrum

Push the **FFT** button to display the FFT side menu. Use the options to select the Source channel, Window algorithm, and FFT Zoom factor. You can display only one FFT spectrum at a time.

FFT option	Settings	Comments
Source On/Off	On, Off	Selects whether the screen displays the source waveform at the same time as it displays the FFT waveform
Source	Ch1, Ch2	Selects the channel used as the FFT source
Window	Hanning, Flattop, Rectangular	Selects the FFT window type; (See page 54, <i>Selecting an FFT Window.</i>)
FFT Zoom	X1, X2, X5, X10	Changes the horizontal magnification of the FFT display; (See page 57, <i>Magnifying and Positioning an FFT Spectrum.</i>)

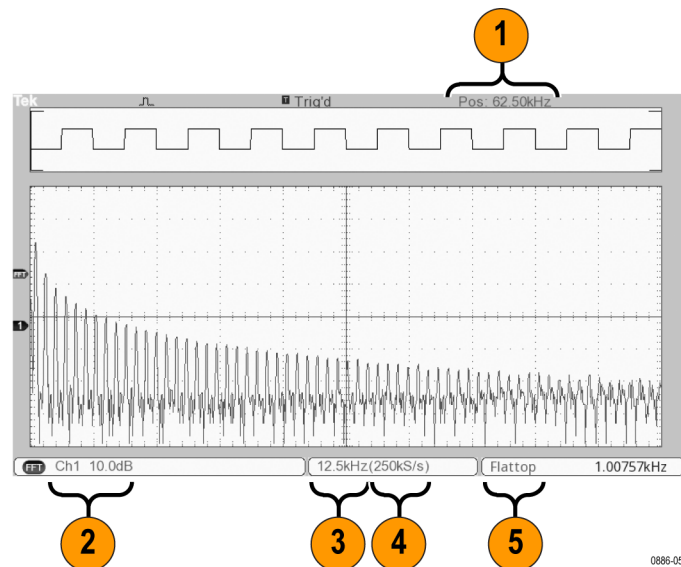

1. Frequency at the center graticule line.
2. Vertical scale in dB per division ($0 \text{ dB} = 1 V_{\text{RMS}}$).
3. Horizontal scale in frequency per division.
4. Sample rate in number of samples per second.
5. FFT window type.

Selecting an FFT Window

Windows reduce spectral leakage in the FFT spectrum. The FFT assumes that the YT waveform repeats forever. With an integral number of cycles (1, 2, 3, ...), the YT waveform starts and ends at the same amplitude and there are no discontinuities in the signal shape.

A non-integral number of cycles in the YT waveform causes the signal start and end points to be at different amplitudes. The transitions between the start and end points cause discontinuities in the signal that introduce high-frequency transients.

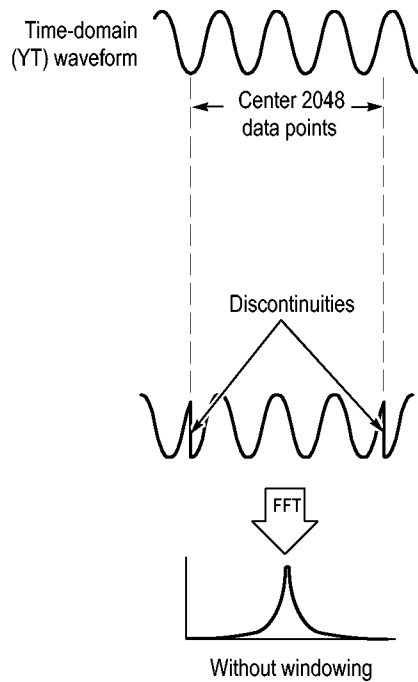

Applying a window to the YT waveform changes the waveform so that the start and stop values are close to each other, reducing the discontinuities.

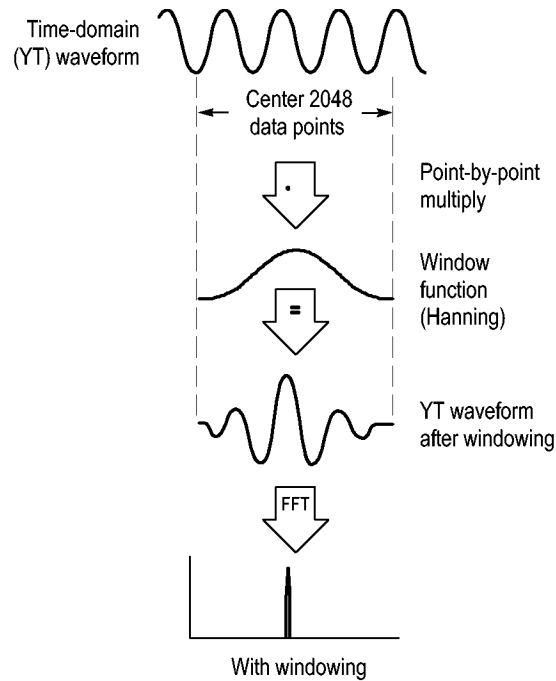

The FFT function includes three FFT Window options. There is a trade-off between frequency resolution and amplitude accuracy with each type of window. What you want to measure and your source signal characteristics will help you to determine which window to use.

Window	Measure	Characteristics
Hanning	Periodic waveforms	Better frequency, poorer magnitude accuracy than Flattop
Flattop	Periodic waveforms	Better magnitude, poorer frequency accuracy than Hanning
Rectangular	Pulses or transients	Special-purpose window for waveforms that do not have discontinuities. This is essentially the same as no window

FFT Aliasing

Problems occur when the oscilloscope acquires a time-domain waveform containing frequency components that are greater than the Nyquist frequency. (See page 52, *Nyquist Frequency*.) The frequency components that are above the Nyquist frequency are undersampled, appearing as lower frequency components that "fold back" around the Nyquist frequency. These incorrect components are called aliases.

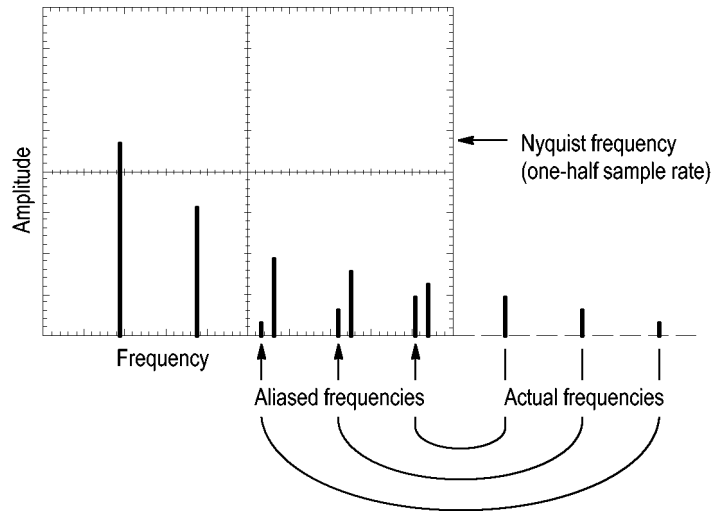

Eliminating Aliases

To eliminate aliases, try the following remedies:

- Turn the **Horizontal Scale** (seconds/division) knob to set the sample rate to a faster setting. Since you increase the Nyquist frequency as you increase the sample rate, the aliased frequency components appear at their proper frequency. If too many frequency components are shown on the screen, you can use the FFT Zoom option to magnify the FFT spectrum.
- If you do not need to view frequency components above 20 MHz, set the Bandwidth Limit option to On.
- Put an external filter on the source signal to bandwidth limit the source waveform to frequencies below that of the Nyquist frequency.
- Recognize and ignore the aliased frequencies.
- Use zoom controls and the cursors to magnify and measure the FFT spectrum.

Magnifying and Positioning an FFT Spectrum

You can magnify and use cursors to take measurements on the FFT spectrum. The oscilloscope includes an FFT Zoom option to magnify horizontally. To magnify vertically, you can use the vertical controls.

Horizontal Zoom and Position

The FFT Zoom option lets you horizontally magnify the FFT spectrum without changing the sample rate. Zoom factors are X1 (default), X2, X5, and X10. At zoom factor X1, and with the waveform centered in the graticule, the left graticule line is at 0 Hz and the right graticule line is at the Nyquist frequency.

When you change the zoom factor, the FFT spectrum is magnified about the center graticule line. In other words, the axis of horizontal magnification is the center graticule line.

Turn the **Horizontal Position** knob clockwise to move the FFT spectrum to the right. Push the **Set To Zero** button to position the center of the spectrum at the center of the graticule.

Vertical Zoom and Position

The channel vertical knobs become vertical zoom and position controls for their respective channels when displaying the FFT spectrum. The **Vertical Scale** knob provides zoom factors of X0.5, X1 (default), X2, X5, and X10. The FFT spectrum is vertically magnified about the M marker (math waveform reference point on the left edge of the screen).

Turn the **Vertical Position** knob clockwise to move the spectrum up for the source channel.

Measuring an FFT Spectrum Using Cursors

You can take two measurements on FFT spectrums: magnitude (in dB), and frequency (in Hz). Magnitude is referenced to 0 dB, where 0 dB equals $1 V_{\text{RMS}}$.

You can use the cursors to take measurements at any zoom factor. To do so, follow these steps:

1. Push the **Cursor** button to see the cursor side menu.
2. Push **Source** ► **FFT**.
3. Push the **Type** option button and use the **Multipurpose** knob to select **Magnitude** or **Frequency**.
4. Select **Cursor 1** or **Cursor 2**.
5. Use the multipurpose knob to move the selected cursor.

Use horizontal cursors to measure magnitude and vertical cursors to measure frequency. The options display the delta between the two cursors, the value at cursor 1 position, and the value at cursor 2 position. Delta is the absolute value of cursor 1 minus cursor 2.

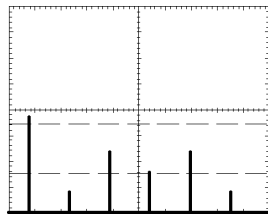

Magnitude cursors

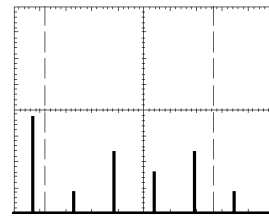

Frequency cursors

You can also take a frequency measurement without using the cursors. To do so, turn the Horizontal Position knob to position a frequency component on the center graticule line and read the frequency at the top right of the display.

USB Flash Drive and Device Ports

This chapter describes how to use the Universal Serial Bus (USB) ports on the oscilloscope to do the following tasks:

- Save and recall waveform data or setup data, or save a screen image
- Transfer waveform data, setup data, or a screen image to a PC
- Control the oscilloscope with remote commands

To use the PC Communications software, launch and refer to the online help from the software.

USB Flash Drive Port

The front of the oscilloscope has a USB Flash Drive port to accommodate a USB flash drive for file storage. The oscilloscope can save data to and retrieve data from the flash drive.



USB Flash Drive port

NOTE. *The oscilloscope can only support flash drives with a storage capacity of 64 GB or less.*

To connect a USB flash drive, follow these steps:

1. Align the USB flash drive with the USB Flash Drive port on the oscilloscope. Flash drives are shaped for proper installation.
2. Insert the flash drive into the port until the drive is fully inserted.

For flash drives with an LED, the drive "blinks" while the oscilloscope writes data to or reads data from the drive. The oscilloscope also displays a clock symbol to indicate when the flash drive is active.

After a file is saved or retrieved, the LED on the drive (if any) stops blinking, and the oscilloscope removes the clock. A hint line also displays to notify you that the save or recall operation is complete.

To remove a USB flash drive, wait until the LED on the drive (if any) stops blinking or until the hint line appears that says the operation is complete, grab the edge of the drive, and extract the drive from the port.

Flash Drive Initial Read Time The oscilloscope reads the internal structure of a USB flash drive each time you install a drive. The time to complete the read depends on the size of the flash drive, how the drive is formatted, and the number of files stored on the drive.

NOTE. *To significantly shorten the initial read time of 64 MB and larger USB flash drives, format the drive on your PC.*

Formatting a Flash Drive The Format function deletes all data on the USB flash drive. To format a flash drive, follow these steps:

1. Insert a USB flash drive into the Flash Drive port on the front of the oscilloscope.
2. Push the **Utility** button to see the Utility Menu.
3. Push **File Utilities ► More ► Format**.
4. Select **Yes** to format the flash drive.

Flash Drive Capacities The oscilloscope can store the following types and number of files per 1 MB of USB flash drive memory:

- 5 Save All operations; (See page 63, *Saves All to Files*.) (See page 91, *Save All*.)
- 16 screen image files (capacity depends on the image format); (See page 64, *Saves Image to File*.) (See page 92, *Save Image*.)
- 250 oscilloscope setting (.SET) files; (See page 92, *Save Setup*.)
- 18 waveform (.CSV) files; (See page 93, *Save Waveform*.)

File Management Conventions

The oscilloscope uses the following file management conventions for data storage:

- The oscilloscope checks for available space on the USB flash drive before writing files, and displays a warning message if there is not enough memory available.
- The term “folder” refers to a directory location on the USB flash drive.
- The default location for the file save or file recall functions is the current folder.
- /usb0/ is the root folder.
- The oscilloscope resets the current folder to /usb0/ when you power on the oscilloscope, or when you insert a USB flash drive after the oscilloscope is powered on.

- File names can have one to eight characters, followed by a period, and then followed with an extension of one to three characters.
- The oscilloscope displays long file names created on PC operating systems with the shortened file name from the operating system.
- File names are case insensitive and are displayed in upper case.

You can use the File Utilities menu to do the following tasks:

- List the contents of the current folder
- Select a file or folder
- Navigate to other folders
- Create, rename, and delete files and folders
- Format the USB flash drive

(See page 104, *File Utilities for the USB Flash Drive*.)

Saving and Recalling Files With a USB Flash Drive

There are two ways to operate the USB flash drive for file storage:

- through the Save/Recall menu
- through the alternative Save function of the front-panel Save button 

You can use the following Save/Recall menu options to write data to or retrieve data from a USB flash drive:

- Save Image
- Save Setup
- Save Waveform
- Recall Setup
- Recall Waveform

NOTE. *The front-panel Save button  can be used as a save button for quick storage of files to a flash drive. For information on how to save many files at once, or images one after another, refer to Using the Save Functions of the Front-Panel Save Button. (See page 63, Using the Save Function of the Front-Panel Save Button.)*

Save Image, Save Setup, and Save Waveform Options

You can save a screen image, the oscilloscope settings, or waveform data to a file on the USB flash drive through the Save/Recall menu.

Each save option operates in a similar way. As an example, to save a screen image file to a flash drive, follow these steps:

1. Insert a USB flash drive into the USB Flash Drive port.
2. Push **Utility ► Options ► Printer Setup** and set the following options:

Ink Saver	On, Off	Saves the screen image on a white background when you select On
Layout	Portrait, Landscape	Orients the screen shot

3. Access the screen you want to save.
4. Push the **Save/Recall** front-panel button.
5. Select the **Action ► Save Image ► Save** option.

The oscilloscope saves the screen image in the current folder and automatically generates the file name. (See page 91, *Save/Recall*.)

Recall Setup, and Recall Waveform Options

You can recall the oscilloscope settings or waveform data from a file on the USB flash drive through the Save/Recall menu.

Each recall option operates in a similar way. As an example, to recall a waveform file from a USB flash drive, follow these steps:

1. Insert the USB flash drive that contains the desired waveform file into the USB Flash Drive port on the front of the oscilloscope.
2. Push the **Save/Recall** front panel button.
3. Select the **Action ► Recall Waveform ► Select File** option.

You can use the Change Folder option to navigate to another folder on the flash drive.

4. Turn the multipurpose knob to select the waveform file to recall.
The name of the file in the Recall option changes as you scroll.
5. Select the **To** option and specify which reference memory location to recall the waveform to (RefA or RefB).
6. Push the **Recall FnnnnCHx.CSV** option button, where FnnnnCHx.CSV is the name of the waveform file.

NOTE. For folders on the flash drive that contain one waveform file, select the **Save/Recall ► Action ► Recall Waveform ► To** option and specify the reference memory location to recall the waveform to. The name of the file appears in the **Recall** option. (See page 91, *Save/Recall*.)

Using the Save Function of the Front-Panel Save Button

You can set the save front panel button to write data to the USB flash drive as an alternative function. To set the function of the button to save data, access one of the following options:

- **Save/Recall ► Action - Save All ► Front-panel Save Button** 
- **Utility ► - more - page 1 of 2 ► Options ► Printer Setup**

Saves All to Files

The Saves All to Files option lets you save the current oscilloscope information to files on the USB flash drive. A single Saves All to Files action uses less than 700 kB of space on the flash drive.

Before you can save data to the USB flash drive, you need to change the front-panel Save button  to the alternative Save function. To do so, select the **Save/Recall ► Save All ► Print Button ► Saves All to Files** option.

To save all the oscilloscope files to a USB flash drive, follow these steps:

1. Insert a USB flash drive into the USB Flash Drive port.
2. To change the folder designated as the current folder, push the **Select Folder** option button.

The oscilloscope creates a new folder within the current folder each time you push the front panel Save button, and automatically generates the folder name.

3. Set up the oscilloscope to capture your data.
4. Push the Save button. 

The oscilloscope creates a new folder on the flash drive and saves the screen image, waveform data, and setup data in separate files in that new folder, using the current oscilloscope and file format settings. The oscilloscope names the folder ALLnnnn. (See page 91, *Save/Recall*.)

To see a list of the files created by the Saves All To Files function, access the **Utility ► File Utilities** menu.

Source	File name
Ch(x)	FnnnnCHx.CSV, where nnnn is an automatically-generated number, and x is the channel number
Math	FnnnnMTH.CSV
Ref(x)	FnnnnRFx.CSV, where x is the reference memory letter
Screen Image	FnnnnTEK.???, where ??? is the current file format
Settings	FnnnnTEK.SET

File type	Contents and uses
.CSV	Contains ASCII text strings that list the time (relative to the trigger) and amplitude values for each of the 2500 waveform data points; you can import .CSV files into many spreadsheet and math analysis applications.
.SET	Contains an ASCII text string listing of the oscilloscope settings; refer to the <i>TBS1000B, TDS2000C and TPS2000 Series Digital Oscilloscopes Programmer Manual</i> to decode strings.
Screen images	Import files into spreadsheet and word processing applications; type of image file depends on the application.

NOTE. *The oscilloscope stores these settings until you change them, even if you push the **Default Setup** button.*

Saves Image to File

This option lets you save the oscilloscope screen image to a file named TEKnnnn.???, where the ??? is the current Saves Image to File format. The next table lists the file formats.

File format	Extension	Comments
BMP	BMP	This bitmap format uses a lossless algorithm, and is compatible with most word processing and spreadsheet programs; this is the default.
JPEG	JPG	This bitmap format uses a lossy compression algorithm, and is commonly used by digital cameras and by other digital photographic applications.

Before you can save data to the USB flash drive, you must change the Save button to the alternative Save function. To do so, select the **Save/Recall ► Save All ► Print Button ► Saves Image to File** option.

To save a screen image to a USB flash drive, follow these steps:

1. Insert a USB flash drive into the USB Flash Drive port.
2. To change the folder designated as the current folder, push the **Select Folder** option button.
3. Access the screen you want to save.
4. Push the front-panel Save button. 

The oscilloscope saves the screen image and automatically generates the file name.

To see a list of the files created by the Save Image To File function, you can access the **Utility ► File Utilities** menu.

USB Device Port

You can use a USB cable to connect the oscilloscope to a PC. The USB Device port is on the rear of the oscilloscope.

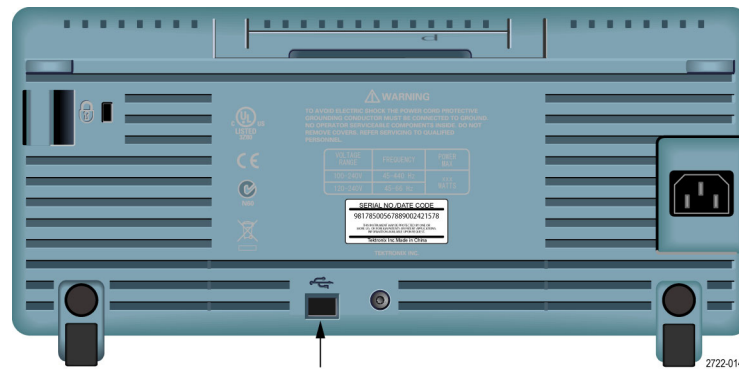

USB Device port

Installing the PC Communications Software on a PC

Before you connect the oscilloscope to a PC with Tektronix OpenChoice PC Communications Software, you must download that software from www.tektronix.com/software and install it on your PC.



CAUTION. *If you connect the oscilloscope to your PC before you install the software, the PC will not recognize the oscilloscope. The PC will label the oscilloscope as an Unknown Device and not communicate with the oscilloscope. To avoid this, install the software on your PC before you connect the oscilloscope to your PC.*

NOTE. *Be sure you have installed the latest version of PC Communications software.*

Software for your oscilloscope is available through the Software finder on the Tektronix web site.

To install the PC Communications software, follow these steps:

1. Run the OpenChoice Desktop software on the PC. The InstallShield wizard appears on the screen.
2. Follow the on-screen directions.
3. Exit the InstallShield wizard.

Connecting to a PC

After you install the software on your PC, you can connect the oscilloscope to the PC.

NOTE. *You must install the software before you connect the oscilloscope to the PC. (See page 65, Installing the PC Communications Software on a PC.)*

To connect the oscilloscope to the PC, follow these steps:

1. Power on the oscilloscope.
2. Insert one end of a USB cable into the USB Device port on the back of the oscilloscope.
3. Power on the PC.
4. Insert the other end of the cable into the desired USB port on a PC.
5. If a Found New Hardware message appears, follow the on-screen directions for the Found New Hardware wizard.

Do NOT search for the hardware to install on the web.

6. For a Windows XP systems, follow these steps:
 - a. If you see the Tektronix PictBridge Device dialog box, click Cancel.
 - b. When prompted, select the option that tells Windows NOT to connect to Windows Update, and click Next.
 - c. In the next window, you should see that you are installing software for a USB Test and Measurement Device. If you do not see USB Test and Measurement Device software, the OpenChoice Desktop software is not properly installed.
 - d. Select the option that installs the software automatically (the recommended option) and click Next.

Windows will install the driver for your oscilloscope.

- e. If you do not see the USB Test and Measurement Device in step c, or if Windows cannot find the software driver, the OpenChoice Desktop software is not properly installed.

In these situations, click Cancel to exit the Found New Hardware wizard. Do NOT allow the wizard to finish.

Unplug the USB cable from your oscilloscope and install the OpenChoice Desktop software.

Reconnect your oscilloscope to the PC and follow steps 6a, 6b, 6c, and 6d.

4. Run your GPIB software on your GPIB system.
5. If the oscilloscope and your GPIB system do not communicate, refer to the information on the software for your GPIB system, and to the user manual for the TEK-USB-488 adapter to resolve the problem.

Command Entry

NOTE. *For complete command information, refer to the TBS1000B, TDS2000C and TPS2000 Series Digital Oscilloscopes Programmer Manual, 077-0444-XX.*

Reference

This chapter describes the menus and operating details associated with each front-panel menu button or control.

Acquire

Push the **Acquire** button to set acquisition parameters.

Options	Settings	Comments
Sample		Use to acquire and accurately display most waveforms; this is the default mode
Peak Detect		Use to detect glitches and reduce the possibility of aliasing
Average		Use to reduce random or uncorrelated noise in the signal display; the number of averages is selectable
Averages	4, 16, 64, 128	Select number of averages

Key Points

If you probe a noisy square wave signal that contains intermittent, narrow glitches, the waveform displayed will vary depending on the acquisition mode you choose.

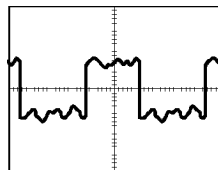

Sample

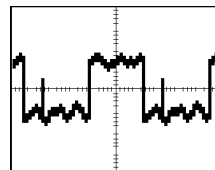

Peak Detect

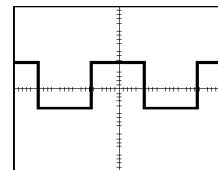

Average

Sample. Use Sample acquisition mode to acquire 2500 points and display them at the horizontal scale (seconds/division) setting. Sample mode is the default mode.

Sample acquisition intervals (2500)

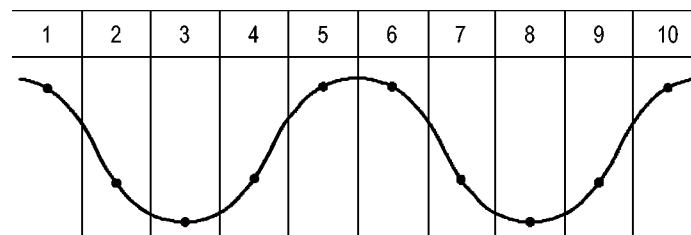

• Sample points

Sample mode acquires a single sample point in each interval.

The oscilloscope samples at the following rates:

- Maximum of 2 GS/s for 100 MHz, 150, and 200 MHz models
- Maximum of 1 GS/s for 50 MHz and 70 MHz models

At 100 ns and faster settings, this sample rate does not acquire 2500 points. In this case, a Digital Signal Processor interpolates points between the sampled points to make a 2500 point waveform record.

Peak Detect. Use Peak Detect acquisition mode to detect glitches as narrow as 10 ns and to limit the possibility of aliasing. This mode is effective when at the horizontal scale setting of 5 ms/division or slower.

Peak Detect acquisition intervals (1250)

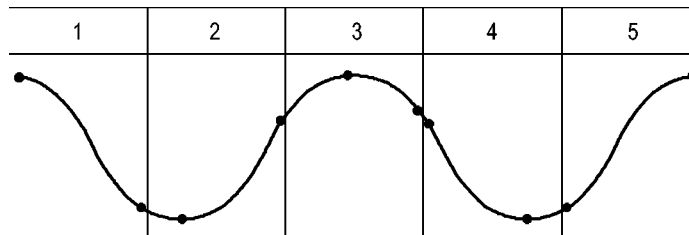

• Sample points displayed

Peak Detect mode displays the highest and lowest acquired voltage in each interval.

NOTE. If you set the horizontal scale (seconds/division) setting to 2.5 ms/div or faster, the acquisition mode changes to Sample because the sample rate is fast enough that Peak Detect is not necessary. The oscilloscope does not display a message to tell you that the mode was changed to Sample.

When there is enough waveform noise, a typical peak detect display shows large black areas. The oscilloscope displays this area with diagonal lines to improve display performance.



Typical peak detect display

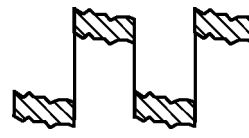

TBS1000B peak detect display

Average. Use Average acquisition mode to reduce random or uncorrelated noise in the signal you want to display. Data is acquired in sample mode, then a number of waveforms are averaged together.

Select the number of acquisitions (4, 16, 64, or 128) to average for the waveform.

Run/Stop Button. Push the **Run/Stop** button when you want the oscilloscope to continuously acquire waveforms. Push the button again to stop the acquisition.

Single Button. Push the **Single** (single sequence) button when you want the oscilloscope to acquire a single waveform and then stop. Each time you push the **Single** button, the oscilloscope begins to acquire another waveform. After the oscilloscope detects a trigger it completes the acquisition and stops.

Acquisition mode	Single button
Sample, Peak Detect	Sequence is complete when one acquisition is acquired
Average	Sequence is complete when the defined number of acquisitions is reached; (See page 69, <i>Acquire</i> .)

Scan Mode Display. You can use the Horizontal Scan acquisition mode (also called Roll mode) to continuously monitor signals that change slowly. The oscilloscope displays waveform updates from the left to the right of the screen and erases old points as it displays new points. A moving, one-division-wide blank section of the screen separates the new waveform points from the old.

The oscilloscope changes to the Scan acquisition mode when you turn the **Horizontal Scale** knob to 100 ms/div or slower, and select the Auto Mode option in the Trigger Menu.

To disable Scan mode, push the **Trigger Menu** button and set the Mode option to Normal.

Stopping the Acquisition. While the acquisition is running, the waveform display is live. Stopping the acquisition (when you push the **Run/Stop** button) freezes the display. In either mode, the waveform display can be scaled or positioned with the vertical and horizontal controls.

Autorange

When you hold the **Autoset** button for more than 1.5 seconds, the oscilloscope activates or deactivates the Autorange function.

This function automatically adjusts setup values to track a signal. If the signal changes, the setup continues to track the signal. When you power on the oscilloscope, autoranging is always inactive.

Options	Comment
Autoranging	Activates or deactivates the Autorange function
Vertical and Horizontal	Tracks and adjusts both axes
Vertical Only	Tracks and adjusts the Vertical scale; does not change the horizontal settings
Horizontal Only	Tracks and adjusts the Horizontal scale; does not change the vertical settings
Undo Autoranging	Causes the oscilloscope to recall the previous setup

The following conditions cause autorange to adjust settings:

- Too many or too few waveform periods for a clear display of the trigger source (except when in Vertical Only)
- Waveform amplitude too large or too small (except when in Horizontal Only)
- Ideal trigger level changes

When you push the **Autoset** button for more than 1.5 seconds, the oscilloscope enters the autorange mode and adjusts controls to produce a usable display of the input signal.

Function	Setting
Acquire mode	Sample
Display format	YT
Display persist	Off
Horizontal position	Adjusted
Horizontal view	Main
Run/Stop	RUN
Horizontal scale (seconds/division)	Adjusted
Trigger coupling	DC
Trigger holdoff	Minimum
Trigger level	Adjusted
Trigger mode	Edge
Vertical bandwidth	Full
Vertical BW limit	Off
Vertical coupling	DC
Vertical invert	Off
Vertical scale (volts/division)	Adjusted

The following changes to the setup of the oscilloscope deactivate autorange:

- Vertical scale deactivates vertical autoranging
- Horizontal scale deactivates horizontal autoranging
- Display or remove a channel waveform
- Trigger settings
- Single sequence acquisition mode
- Recall a setup
- XY Display format
- Persistence

The Autorange function is usually more useful than Autoset in the following situations:

- Analyzing a dynamically changing signal
- Quickly comparing a sequence of several signals without adjusting the oscilloscope. This is very useful if you need to use two probes at the same time, or if you need to use a probe in one hand and are holding something else in the other.
- Controlling which settings the oscilloscope automatically adjusts

If your signals vary in frequency, but have similar amplitudes, you can use Horizontal Only autoranging. The oscilloscope will adjust the horizontal settings, but leave the vertical settings unchanged. This way, you can visually estimate the amplitude of the signal without worrying about the vertical scale changing. Vertical Only autoranging works similarly, adjusting vertical parameters and leaving the horizontal settings unchanged.

Autoset

When you push the **Autoset** button once, the oscilloscope identifies the type of waveform and adjusts controls to produce a usable display of the input signal.

When you press the button for more than 1.5 seconds, it will perform the Autorange function. It will display the Autorange Menu and activate or deactivate the autoranging function.

Function	Setting
Acquire mode	Adjusted to Sample or Peak Detect
Cursors	Off
Display format	Set to YT
Display type	Set to Dots for a video signal, set to Vectors for an FFT spectrum; otherwise, unchanged
Horizontal position	Adjusted
Horizontal scale (seconds/division)	Adjusted
Trigger coupling	Adjusted to DC, Noise Reject, or HF Reject
Trigger holdoff	Minimum
Trigger level	Set to 50%
Trigger mode	Auto
Trigger source	Adjusted; refer to the information after this table; cannot use Autoset on the Ext Trig signal
Trigger slope	Adjusted
Trigger type	Edge or Video
Trigger Video Polarity	Normal

Function	Setting
Trigger Video Sync	Adjusted
Trigger Video Standard	Adjusted
Vertical bandwidth	Full
Vertical coupling	DC (if Ground was previously selected); AC for a video signal; otherwise, unchanged
Volts/Div	Adjusted

The Autoset function examines all channels for signals and displays corresponding waveforms. Autoset also determines the trigger source based on the following conditions:

- If multiple channels have signals, the oscilloscope displays the channel with the lowest frequency signal.
- If no signals are found, then the oscilloscope displays the lowest-numbered channel when Autoset was invoked.
- If no signals are found and no channels are displayed, then the oscilloscope displays and uses channel 1.



When you use Autoset and the oscilloscope cannot determine the signal type, the oscilloscope adjusts the horizontal and the vertical scales, then takes the Mean and Pk-to-Pk automatic measurements.

The Autoset function is usually more useful than Autorange in the following situations:

- Troubleshooting one stable signal
- Automatically seeing measurements of your signal
- Easily changing how the signal is presented. For example, viewing only one cycle of the waveform, or the rising edge of the waveform
- Viewing video signals or FFT signals

Sine Wave





When you use the Autoset function and the oscilloscope determines that the signal is similar to a sine wave, the oscilloscope displays the following options:

Sine wave	Details
 Multi-cycle sine	Displays several cycles with appropriate vertical and horizontal scaling; the oscilloscope displays Cycle RMS, Frequency, Period, and Peak-to-Peak automatic measurements
 Single-cycle sine	Sets the horizontal scale to display about one cycle of the waveform; the oscilloscope displays Mean, and Peak-to-Peak automatic measurements

Sine wave	Details
 FFT	Converts the input time-domain signal into its frequency components and displays the result as a graph of frequency versus magnitude (spectrum). Refer to the <i>FFT</i> chapter for more information (See page 51, <i>FFT</i> .)
Undo Autoset	Causes the oscilloscope to recall the previous setup





Square Wave or Pulse

When you use the Autoset function and the oscilloscope determines that the signal is similar to a square wave or pulse, the oscilloscope displays the following options:

Square wave or	Details
 Multi-cycle square	Displays several cycles with appropriate vertical and horizontal scaling; the oscilloscope displays Pk-Pk, Mean, Period, and Frequency automatic measurements
 Single-cycle square	Sets the horizontal scale to display about one cycle of the waveform; the oscilloscope displays Min, Max, Mean, and Positive Width automatic measurements
 Rising edge	Displays the edge, and the Rise Time and Peak-to-Peak automatic measurements
 Falling edge	Displays the edge, and the Fall Time and Peak-to-Peak automatic measurements
Undo Autoset	Causes the oscilloscope to recall the previous setup

Video Signal

When you use the Autoset function and the oscilloscope determines that the signal is a video signal, the oscilloscope displays the following options:

Video signal options	Details
 Fields ► All Fields	Displays several fields and the oscilloscope triggers on any field
 Lines ► All Lines	Displays one complete line with parts of the previous and next line; the oscilloscope triggers on any line
 Lines ► Number	Displays one complete line with parts of the previous and next line; use the multipurpose knob to select a specific line number for the oscilloscope to use as a trigger
 Odd Fields	Displays several fields and the oscilloscope triggers only on odd numbered fields

Video signal options	Details
 Even Fields	Displays several fields and the oscilloscope triggers only on even numbered fields
Undo Autoset	Causes the oscilloscope to recall the previous setup

NOTE. Video autoset sets the Display Type option to Dot Mode.

Counter

Use the counter function from the **Function** button menu to simultaneously monitor two different signal frequencies. This feature provides a more accurate reading than is available with the frequency measurement.

Options	Settings	Comments
Ch1	On, Off	
Ch2	On, Off	
Ch1 Trigger		Use the multipurpose knob to set the trigger level.
Ch2 Trigger		Use the multipurpose knob to set the trigger level.

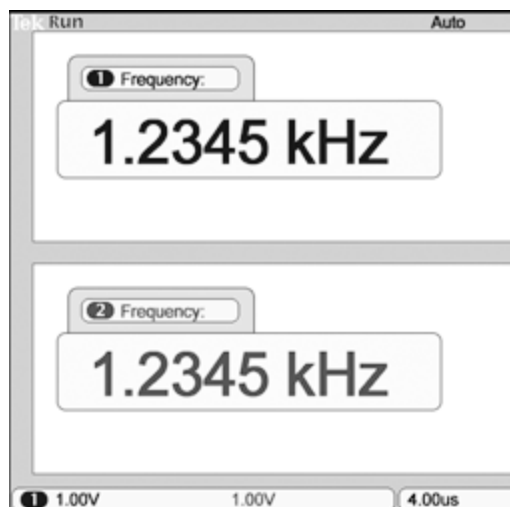

Course (EDU models only)

Run labs right on your oscilloscope. Also, read theory and procedures, and capture your lab results right there as well.

Create your course on a PC:

Create new course materials on a PC with separate PC-based software, which you can download from www.tektronix.com/software or find on a CD that accompanied your oscilloscope. After you create the materials, you can distribute them to TBS1000B-EDU oscilloscopes using a USB flash memory device.

You can also check at www.tektronix.com for a separate Courseware Web page, where you can find copies of labs that others have created and uploaded to share.

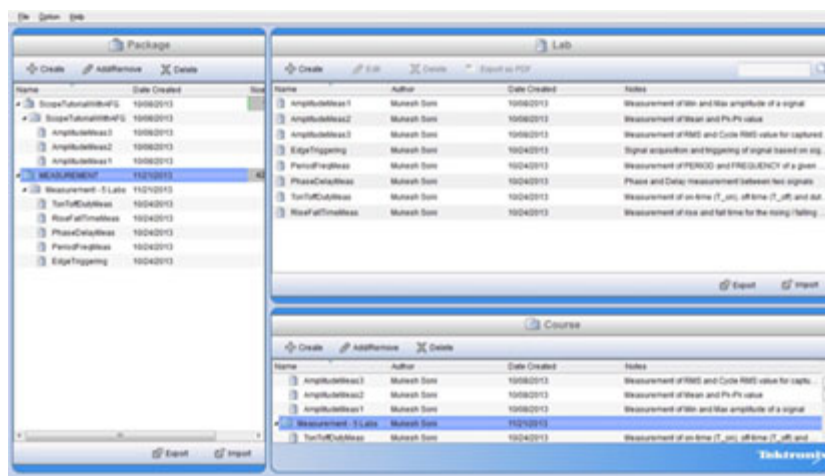

Load your course on your TBS1000B-EDU:

To load a new course on a TBS1000B-EDU oscilloscope,

1. Insert the USB memory device that contains your course into the front-panel USB slot of your TBS1000B-EDU.
2. Push **Utility** ► - more - page 1 of 3 ► **Update Course**.
3. Use the **Multipurpose** knob to scroll through the resulting file list and to highlight the desired course folder. Course folders have an .xpkg suffix.
4. Push **Upload Course** to load the course into your oscilloscope.

Run labs on your TBS1000B-EDU:

You can access the lab content via the dedicated **Course** button located on the front panel. Use the oscilloscope's soft keys and the multipurpose knob to access up to 8 courses, which can have up to 30 labs each. Store up to 100 MB of course material on the oscilloscope. Once you choose a lab, you can review the overview section, perform the lab using the step-by-step procedure, collect data, check and save the data results and generate reports that show the waveforms created for each step in the procedure.

To run your desired lab:

1. Push the **Course** front-panel button to enable operation of courseware directly on the oscilloscope.
2. Push a side-bezel menu item to choose the desired course from those listed.
3. Turn the **Multipurpose** knob to highlight the lab to run. Push the knob to select the desired lab.
4. On the resulting screen, select the desired content from the side-bezel menu. Read the **Overview** and the step-by-step **Procedure**. Push **Data Collection** and save results to a USB memory device.
5. When done running the lab, select **Report** from the side-bezel menu. Use the resulting side-bezel menu to enter your student identification number.
6. Push **OK** from the side-bezel menu.
7. On the resulting course report, push **Save** on the side-bezel menu. This will save the report onto an attached USB memory device.

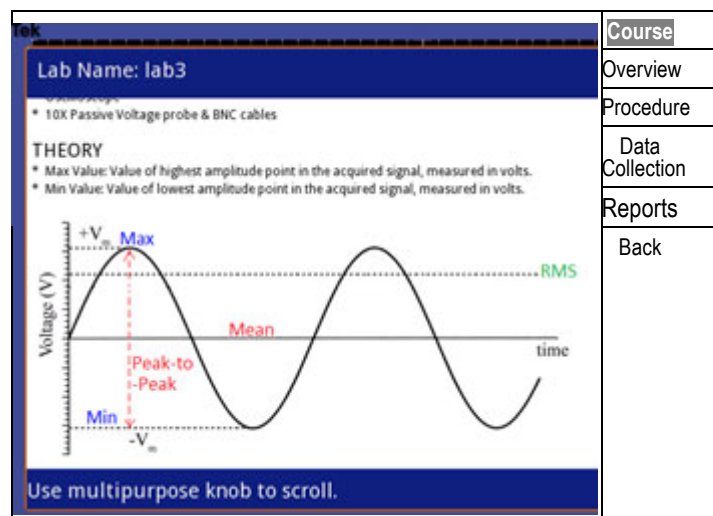

Cursor

Push the **Cursor** button to display the measurement cursors and Cursor Menu, and then use the multipurpose knob to change the position of a cursor.

Options	Settings	Comments
Type ¹	Time, Amplitude, Off	Select and display the measurement cursors; Time measures time, frequency, and amplitude; Amplitude measures amplitude, such as current or voltage
Source	Ch1, Ch2, FFT, Math, Ref A, Ref B	Choose the waveform on which to take the cursor measurements Cursor readouts display the measurement
Δ		Displays the absolute value of the difference (delta) between the cursors
Cursor 1 Cursor 2		Displays selected cursor location (time is referenced to the trigger position, and amplitude to the reference connection)

¹ For an FFT source, measures Frequency and Magnitude.

Delta (Δ) values vary with the following types of cursors:

- Time cursors display Δt , $1/\Delta t$ and ΔV (or ΔI , ΔVV , and so on)
- Amplitude cursors, and Magnitude cursors (FFT source) display ΔV , ΔI , ΔVV , and so on
- Frequency cursors (FFT source) display $1/\Delta \text{Hz}$ and ΔdB

NOTE. The oscilloscope must display a waveform for the cursors and cursor readouts to appear.

NOTE. The oscilloscope displays the time and amplitude values for each waveform when you use Time cursors.

Key Points

Cursor Movement. Use the multipurpose knob to move Cursor 1 or Cursor 2. You can move the cursors only while the Cursor Menu is displayed. The active cursor is represented by a solid line.

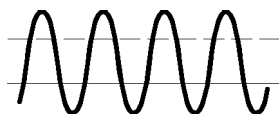

Amplitude cursors

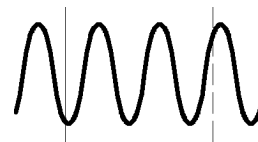

Time cursors

Default Setup

Push the **Default Setup** button to recall most of the factory option and control settings, but not all. Appendix D lists the default settings that will be recalled.

Display

Push the **Utility** button and **Display** side-menu selection to choose how waveforms are presented and to change the appearance of the entire display.

Options	Settings	Comments
Type	Vectors, Dots	Vectors fill the space between adjacent sample points in the display Dots display only the sample points
Persist	Off, 1 sec, 2 sec, 5 sec, Infinite	Sets the length of time each displayed sample point remains displayed
Format	YT, XY	YT format displays the vertical voltage in relation to time (horizontal scale) XY format displays a dot each time a sample is acquired on channel 1 and channel 2 Channel 1 voltage or current determines the X coordinate of the dot (horizontal) and the channel 2 voltage or current determines the Y coordinate (vertical)
Backlight	0 to 100%	Use the Multipurpose knob to adjust the display backlight.

Depending on the type, waveforms will be displayed in three different styles: solid, dimmed, and broken.

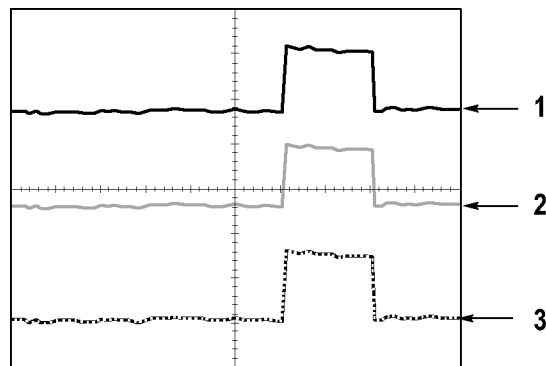

1. A solid waveform indicates a channel (live) waveform display. The waveform remains solid when the acquisition is stopped if no controls are changed that make the display accuracy uncertain.

Changing the vertical and horizontal controls is allowed on stopped acquisitions.

2. Reference waveforms appear white and waveforms with persistence applied appear in the same color as the Main waveform, but with less intensity.
3. A broken line indicates the waveform display no longer matches the controls. This happens when you stop the acquisition, and change a control setting that the oscilloscope is not able to apply to the displayed waveform. For example, changing the trigger controls on a stopped acquisition causes a broken-line waveform.

Key Points

Persistence. The oscilloscope displays persistence waveform data with less intensity than "live" waveform data. With Persistence set to Infinite, record points accumulate until a control is changed.

Option	Comments
Off	Removes default or old waveforms whenever new waveforms display
Time limit	Displays new waveforms at normal intensity and old waveforms at a lower intensity; erases old waveforms when they reach the time limit
Infinite	Older waveforms become less bright but always remain visible; use Infinite persistence to look for infrequent events and to measure long term peak-to-peak noise

XY Format. Use the XY format to analyze phase differences, such as those represented by Lissajous patterns. The format plots the voltage on channel 1 against the voltage on channel 2, where channel 1 is the horizontal axis and channel 2 is the vertical axis. The oscilloscope uses the untriggered Sample acquisition mode and displays data as dots. The sampling rate is fixed at 1 MS/s.

NOTE. *The oscilloscope can capture a waveform in normal YT mode at any sampling rate. You can view the same waveform in XY mode. To do so, stop the acquisition and change the display format to XY.*

In XY format, the controls operate as follows:

- The channel 1 **Vertical Scale** and **Vertical Position** controls set the horizontal scale and position.
- The channel 2 **Vertical Scale** and **Vertical Position** controls continue to set vertical scale and position.

The following functions do not work in XY display format:

- Autoset (resets display format to YT)
- Autorange
- Automatic measurements
- Cursors
- Reference or Math waveforms
- Save/Recall ► Save All
- Time base controls
- Trigger controls

FFT

Options	Settings	Comments
Source waveform	On or Off	
Sources	Ch1 or Ch2	
Window	Hanning, Flattop, or Rectangular	Typically, use Hanning for the best frequency resolution, Flattop for the best magnitude accuracy, and Rectangular for the best transient analysis.
FFT Zoom	X1, X2, X5, or X10	

Function

For non-EDU models, use the **Function** button to access: limit test, data logging, the counter, and the trend plot.

For EDU models, use the **Function** button to access the counter.

Non-EDU models

Options	Settings	Comments
Limit Test	Source	Defines the source of the waveforms against which to run the template waveform
	Compare To	Specifies the limit test template against which to compare the signals defined with the Source menu item.
	Run/Stop Test	Toggles between whether to start or stop the limit test
	Template Setup	Sets up a limit test waveform template. This is the mask signal you define as the boundary to compare with the input source signal. Do this before running a limit test
	Action on Violation	Defines the actions the oscilloscope will take after detecting a violation
	Stop After	Defines the conditions that will cause the oscilloscope to end limit testing
Data Logging	Data Logging	Sets the data logging feature on or off
	Source	Sets the signal source to log data from
	Duration	Sets the time duration of data logging in half hour increments, from 0.5 hour to 8 hours, or in one hour increments, from 8 hours to 24 hours, or to indefinite
	Select Folder	Sets the folder to save the waveform data to
Counter	Ch1, Ch2, Ch1 Trigger, Ch2 Trigger	
Trend plot	Run/Stop, Source 1, Type 1, Source 2, Type 2	Plot a graph of one or two measurements as a function of time.

EDU models

Options	Settings	Comments
Counter	Ch1, Ch2, Ch1 Trigger, Ch2 Trigger	

Help

Push the **Help** button to display the Help menu. The topics cover all the menu options and controls of the oscilloscope.

Horizontal

You can use the horizontal controls to adjust the trigger point location relative to the acquired waveform and to adjust the horizontal scale (time/division).

A readout near the top right of the screen displays the current horizontal position in seconds. The oscilloscope also indicates horizontal position with an arrow icon at the top of the graticule.

Knobs and Buttons

Horizontal Position Knob. Use to control the position of the trigger relative to the center of the screen.

The trigger point can be set to the left or the right of the center of the screen. The maximum number of divisions to the left depends on the Horizontal Scale (time base) setting. For most scales, the maximum is at least 100 divisions. Placing the trigger point off the screen to the left is called Delayed Sweep.

Push to center the trigger on the screen.

Horizontal Scale Knob (seconds/division). Use to change the horizontal time scale to magnify or compress the waveform.

Key Points

Horizontal Scale. If waveform acquisition is stopped (using the **Run/Stop** or **Single** button), the **Horizontal Scale** control expands or compresses the waveform. Use to zoom in on a detail of the waveform.

Scan Mode Display (Roll Mode). When the **Horizontal Scale** control is set to 100 ms/div or slower and the trigger mode is set to *Auto*, the oscilloscope enters the Scan acquisition mode. In this mode, the waveform display updates from left to right. There is no trigger or horizontal position control of waveforms during scan mode. (See page 71, *Scan Mode Display*.)

Math

Push the **Math (M)** button to display waveform math operations. Push the **Math** button again to remove math waveforms. (See page 106, *Vertical Controls*.)

Options	Comments
+, -, ×	Math operations; see the next table
Sources	Sources used for the operations; see the next table

Options	Comments
Position	Use the multipurpose knob to set the vertical position of the resultant Math waveform
Vertical Scale	Use the multipurpose knob to set the vertical scale of the resultant Math waveform

The Math Menu includes Sources options for each operation.

Operation	Sources option	Comments
+ (addition)	Ch1 + Ch2	Channels 1 and 2 are added together
- (subtraction)	Ch1 - Ch2	The channel 2 waveform is subtracted from the channel 1 waveform
	Ch2 - Ch1	The channel 1 waveform is subtracted from the channel 2 waveform
× (multiplication)	Ch1 × Ch2	Channels 1 and 2 are multiplied together

Key Points

Waveform Units. The combination of source waveform units determine the resulting units for the Math waveform.

Waveform unit	Waveform unit	Operation	Resulting Math unit
V	V	+ or -	V
A	A	+ or -	A
V	A	+ or -	?
V	V	×	VV
A	A	×	AA
V	A	×	VA

Measure

Push the **Measure** button to access automatic measurements. There are 34 types of measurements available. You can display up to six at a time.

Push the top option button to display the Measure 1 Menu. You can choose the channel on which to take a measurement in the Source option. You can choose the type of measurement to take in the Type option. Push the Back option button to return to the Measure Menu and display the selected measurements.









Key Points

Taking Measurements. You can display up to six automatic measurements at a time. The waveform channel must be on (displayed) to make a measurement.

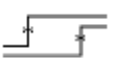
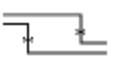
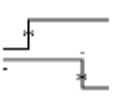
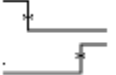

Automated measurements cannot be taken on reference waveforms, or while using XY or scan mode. The measurements update about two times per second.

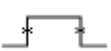
The following tables list each automatic measurement by category: time or amplitude.

Time measurements



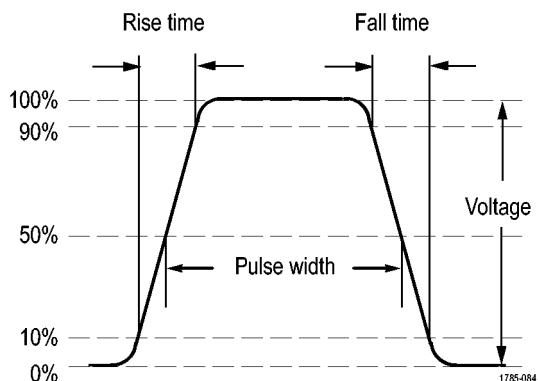

Measurement		Description
Period		The time required to complete the first cycle in a waveform or gated region. Period is the reciprocal of frequency and is measured in seconds.
Frequency		The first cycle in a waveform or gated region. Frequency is the reciprocal of the period; it is measured in hertz (Hz) where one Hz is one cycle per second.
DelayRR (rising to rising)		The time between the mid reference (default 50%) amplitude point of two different rising waveforms. See also <i>Phase</i> .
DelayFF (falling to falling)		The time between the mid reference (default 50%) amplitude point of the two different falling waveforms.
DelayRF (rising to falling)		The time between the mid reference (default 50%) amplitude point of the rising and the falling waveforms.
DelayFR (falling to rising)		The time between the mid reference (default 50%) amplitude point of the falling and the rising waveforms.
Rise Time		The time required for the leading edge of the first pulse in the waveform or gated region to rise from the low reference value (default = 10%) to the high reference value (default = 90%) of the final value.
Fall Time		The time required for the falling edge of the first pulse in the waveform or gated region to fall from the high reference value (default = 90%) to the low reference value (default = 10%) of the final value.
Positive Duty Cycle		The ratio of the positive pulse width to the signal period expressed as a percentage. The duty cycle is measured on the first cycle in the waveform or gated region.
Negative Duty Cycle		The ratio of the negative pulse width to the signal period expressed as a percentage. The duty cycle is measured on the first cycle in the waveform or gated region.
Positive Pulse Width		The distance (time) between the mid reference (default 50%) amplitude points of a positive pulse. The measurement is made on the first pulse in the waveform or gated region.
Negative Pulse Width		The distance (time) between the mid reference (default 50%) amplitude points of a negative pulse. The measurement is made on the first pulse in the waveform or gated region.

Time measurements (cont.)



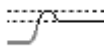



Measurement		Description
Burst Width		The duration of a burst (a series of transient events) and is measured over the entire waveform or gated region.
Phase		The phase angle difference of signals from two different channels, using the rising edge of the first signal compared to the rising edge of the second signal.



Amplitude measurements

Measurement		Description
Positive Overshoot		This is measured over the entire waveform or gated region and is expressed as: Positive Overshoot = $(\text{Maximum} - \text{High}) / \text{Amplitude} \times 100\%$.
Negative Overshoot		This is measured over the entire waveform or gated region and is expressed as: Negative Overshoot = $(\text{Low} - \text{Minimum}) / \text{Amplitude} \times 100\%$.
Pk-Pk		The absolute difference between the maximum and minimum amplitude in the entire waveform or gated region.
Amplitude		The high value less the low value measured over the entire waveform or gated region.
High		This value is used as 100% whenever high reference, mid reference, or low reference values are needed, such as in fall time or rise time measurements. Calculate using either the min/max or histogram method. The min/max method uses the maximum value found. The histogram method uses the most common value found above the midpoint. This value is measured over the entire waveform or gated region.

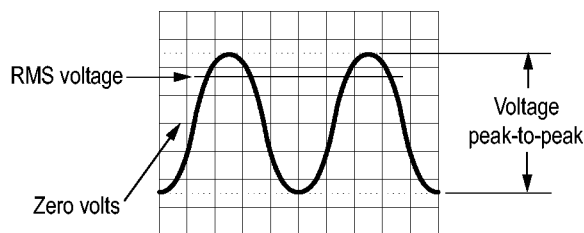

Amplitude measurements (cont.)

Measurement		Description
Low		This value is used as 0% whenever high reference, mid reference, or low reference values are needed, such as in fall time or rise time measurements. Calculate using either the min/max or histogram method. The min/max method uses the minimum value found. The histogram method uses the most common value found below the midpoint. This value is measured over the entire waveform or gated region.
Max		The most positive peak voltage. Max is measured over the entire waveform or gated region.
Min		The most negative peak voltage. Min is measured over the entire waveform or gated region.
Mean		The arithmetic mean amplitude over the entire waveform or gated region.
Cycle Mean		The arithmetic mean over the first cycle in the waveform or the first cycle in the gated region.
RMS		The true Root Mean Square voltage over the entire waveform or gated region.
Cycle RMS		The true Root Mean Square voltage over the first cycle in the waveform or the first cycle in the gated region.









1785-083

Miscellaneous measurements

Measurement		Description
Rising Edge Count		The number of positive transitions from the low reference value to the high reference value in the waveform or gated region.
Falling Edge Count		The number of negative transitions from the high reference value to the low reference value in the waveform or gated region.

Miscellaneous measurements (cont.)

Measurement		Description
Positive Pulse Count		The number of positive pulses that rise above the mid reference crossing in the waveform or gated region.
Negative Pulse Count		The number of negative pulses that fall below the mid reference crossing in the waveform or gated region.
Area		Area measurement is a voltage over time measurement. It returns the area over the entire waveform or gated region in volt-seconds. Area measured above ground is positive; area measured below ground is negative.
Cycle Area		A voltage over time measurement. The measurement is the area over the first cycle in the waveform or the first cycle in the gated region expressed in volt-seconds. The area above the common reference point is positive, and the area below the common reference point is negative.
Cursor Mean		The arithmetic mean of the waveform data from the selected starting to the ending point
Cursor RMS		Calculates a true RMS measurement of the waveform data from the selected starting to the ending point

Measurement Gating

Gating confines the measurement to a portion of a waveform defined by the cursors. To use:

1. Push the **Measure** front panel button.
2. Push the **Measure Gating On/Off** side bezel button.

Menu Off

Push **Menu Off** to clear displayed menus from the screen.

Print-Ready Screenshots

You can set up the oscilloscope to save print-ready images through the **Utility ► - more - page 1 of 3 ► Options ► Printer Setup** menu.

Option	Setting	Comments
Ink Saver	On, Off	Prints the screen image on a white background when you select On
Layout ¹	Portrait, Landscape	Printer output orientation
Abort Printing		Stops sending the screen image to the printer
Paper Size ²	Default, L, 2L, Hagaki Postcard, Card Size, 10 x 15 cm, 4" x 6", 8" x 10", Letter, 11" x 17", A0, A1, A2, A3, A4, A5, A6, A7, A8, A9, B0, B1, B2, B3, B4, B5, B6, B7, B8, B9, 89 mm Roll (L), 127 mm Roll (2L), 100 mm Roll (4"), 210 mm Roll (A4)	Displays settings available on your PictBridge compatible printer
Image Size ²	Default, 2.5 x 3.25 in, L (3.5 x 5 in), 4 x 6 in, 2L (5 x 7 in), 8 x 10 in, 4L (7 x 10 in), E, Card, Hagaki card, 6 x 8 cm, 7 x 10 cm, 9 x 13 cm, 10 x 15 cm, 13 x 18 cm, 15 x 21 cm, 18 x 24 cm, A4, Letter	
Paper Type ²	Default, Plain, Photo, Fast Photo	
Print Quality ²	Default, Normal, Draft, Fine	
Date Print ²	Default, Off, On	
ID Print ²	Default, Off, On	

¹ The printer may override your selection for best fit.

² If your selection is not supported by the printer, the oscilloscope uses the Default setting.

Reference Menu

The Reference menu can turn on or turn off reference memory waveforms from the display. The waveforms are stored in the non-volatile memory of the oscilloscope, and have the following designations: RefA and RefB.

To display (recall) or hide a reference waveform, follow these steps:

1. Push the **Ref** front panel button.
2. Push the side-menu button corresponding to the reference waveform you wish to display or hide.

Reference waveforms have the following characteristics:

- Reference waveforms are displayed in white
- Two reference waveforms can be displayed at the same time
- Vertical and horizontal scale readouts display at the bottom of the screen
- Reference waveforms cannot be zoomed or panned

You can display one or two reference waveforms at the same time as "live" channel waveforms. If you display two reference waveforms, you must hide one waveform before you can display a different one.

Refer to *Save Waveform* for information on how to save reference waveforms. (See page 93, *Save Waveform*.)

Save/Recall

Push the **Save/Recall** button to save oscilloscope setups, screen images, or waveforms, or to recall oscilloscope setups or waveforms.

The Save/Recall menu is made up of many submenus which you can access through an Action option. Each Action option displays a menu that allows you to further define the save or recall function.

Action options	Comments
Save All	Contains the option that configures the Print button to send data to a printer or to save data to a USB flash drive
Save Image	Saves a screen image to a file in a specified format
Save Setup	Saves the current oscilloscope settings to a file in a specified folder or in nonvolatile setup memory
Save Waveform	Saves the specified waveform to a file or to reference memory
Recall Setup	Recalls an oscilloscope setup file from a USB flash drive or from a location in nonvolatile setup memory
Recall Waveform	Recalls a waveform file from a USB flash drive to reference memory

Save All The Save All action configures the Print button to save data to a USB flash drive, or to send data to a printer.

Options	Settings or submenus	Comments
Print Button	Saves All to Files	(See page 63.)
	Saves Image to File	(See page 64.)
	Prints	

Options	Settings or submenus	Comments
Select Folder		Lists the contents of the current USB flash drive folder
	Change Folder	(See page 60, <i>File Management Conventions</i> .) (See page 104, <i>File Utilities for the USB Flash Drive</i> .)
	New Folder	
	Back	Returns to the Save All menu
About Save All		Displays the help topic

Save Image

The Save Image action saves a screen image to a file in a specified format.

Options	Settings or submenus	Comments
File Format	BMP, JPEG	Sets the screen image graphics file format
About Saving Images		Displays the help topic
Select Folder		Lists the contents of the current USB flash drive folder and displays the folder options
	Change Folder	(See page 60, <i>File Management Conventions</i> .) (See page 104, <i>File Utilities for the USB Flash Drive</i> .)
	New Folder	
	Layout ¹ , Portrait, Landscape	Select portrait or landscape image layout
	Ink Saver ¹ , On, Off	Activates or deactivates Ink Saver mode
Save	filename (such as TEK0000.TIF)	Saves the screen image to the automatically generated file name in the current USB flash drive folder

¹ (See page 90, *Print-Ready Screenshots*.)

When the print button option is set to Saves Image to File, the oscilloscope saves screen images to a USB flash drive when you push the Save button. (See page 64, *Saves Image to File*.)

Save Setup

The Save Setup action saves the current oscilloscope settings to a file named TEKnxxx.SET in a specified folder, or in nonvolatile setup memory. A setup file contains an ASCII text string that lists the oscilloscope settings.

Options	Settings or submenus	Comments
Save To	Setup	Saves the current oscilloscope settings to a location in the nonvolatile setup memory
	File	Saves the current oscilloscope settings to a file on the USB flash drive

Options	Settings or submenus	Comments
Setup	1 to 10	Specifies which nonvolatile setup memory location to save to
Select Folder		Lists the contents of the current USB flash drive folder
	Change Folder	(See page 60, <i>File Management Conventions</i> .) (See page 104, <i>File Utilities for the USB Flash Drive</i> .)
	New Folder	(See page 60, <i>File Management Conventions</i> .) (See page 104, <i>File Utilities for the USB Flash Drive</i> .)
Save	filename (such as TEK0000.SET)	Saves the settings to the automatically generated file name in the current USB flash drive folder

When the print button option is set to Saves All to Files, the oscilloscope saves oscilloscope setup files to a USB flash drive when you push the Save button. (See page 63, *Saves All to Files*.)

Save Waveform

The Save Waveform action saves the specified waveform to a file named TEKnnnn.CSV, or to reference memory. The oscilloscope saves waveform data to files as "comma separated values" (.CSV format), which are ASCII text strings that list the time (relative to the trigger) and amplitude values for each of the 2500 waveform data points. You can import .CSV files into many spreadsheet and math analysis applications.

Options	Settings or submenus	Comments
Save To	File	Specifies to save the source waveform data to a file on a USB flash drive
	Ref	Specifies to save the source waveform data in reference memory
Source ¹	Ch(x), Ref(x), Math	Specifies which source waveform to save
To	Ref(x)	Specifies the reference memory location in which to save the source waveform
Select Folder		Lists the contents of the current USB flash drive folder
	Change Folder	(See page 60, <i>File Management Conventions</i> .) (See page 104, <i>File Utilities for the USB Flash Drive</i> .)
	New Folder	(See page 60, <i>File Management Conventions</i> .) (See page 104, <i>File Utilities for the USB Flash Drive</i> .)
Save	filename (such as TEK0000.CSV)	Saves the waveform data to the automatically generated file name in the current USB flash drive folder

¹ Waveform must be displayed to save it as a reference waveform.

Recall Setup

The Recall Setup action recalls an oscilloscope setup file from a USB flash drive or from a location in nonvolatile setup memory.

Options	Settings or submenus	Comments
Recall From	Setup	Specifies to recall a setup from the nonvolatile memory
	File	Specifies to recall a setup file from a USB flash drive
Setup	1 to 10	Specifies which setup location in nonvolatile setup memory to recall
Select File		Lists the contents of the current USB flash drive folder to select a file from
	Change Folder	(See page 60, <i>File Management Conventions</i> .) (See page 104, <i>File Utilities for the USB Flash Drive</i> .)
Recall		Recalls the settings from the specified nonvolatile memory location
	filename (such as TEK0000.SET)	Recalls the oscilloscope settings from the specified USB flash drive file

Recall Waveform

The Recall Waveform action recalls a waveform file from a USB flash drive to a location in reference memory.

Options	Settings or submenus	Comments
To	Ref(x)	Specifies the reference memory location to load the waveform to
From File		Recalls the file from the USB flash drive
Select File		Lists the contents of the current USB flash drive folder and displays the next folder option
	Change Folder	(See page 60, <i>File Management Conventions</i> .) (See page 104, <i>File Utilities for the USB Flash Drive</i> .)
	To	Specifies the reference memory location to recall the waveform to
Recall	filename (such as TEK0000.CSV)	Loads the waveform from the specified file to the location in reference memory and displays the waveform

Key Points

Saving and Recalling Setups. The complete setup is stored in nonvolatile memory. When you recall the setup, the oscilloscope will be in the mode from which the setup was saved.

The oscilloscope saves the current setup if you wait three seconds after the last change before you power off the oscilloscope. The oscilloscope then recalls this setup the next time you apply power.

Recalling the Default Setup. You can push the **Default Setup** button to initialize the oscilloscope to a known setup. To view option and control settings that the oscilloscope recalls when you push this button, refer to *Appendix D: Default Setup*.

Saving and Recalling Waveforms. The oscilloscope must display any waveform that you want to save. Two-channel oscilloscopes can store two reference waveforms in internal nonvolatile memory. Four-channel oscilloscopes can store four, but only display two at a time.

The oscilloscope can display both reference waveforms and channel waveform acquisitions. Reference waveforms are not adjustable, but the oscilloscope displays the horizontal and vertical scales at the bottom of the screen.

Trend Plot (non-EDU models only)

The trend function plots a graph of measurements as a function of time. You can display up to two trend plots simultaneously.

The TrendPlot™ function helps find intermittent faults. To run, select the type of measurements to capture from either or both channels and then set up the oscilloscope to continuously monitor the signals, plot the data onto the display and simultaneously save the information to a USB memory device. You'll be able to capture data for minutes, hours or days. Just evaluate your requirement and the size of your USB memory device and then adjust your oscilloscope settings.

To operate:

Options	Settings	Comments
Run, Stop	Run, Stop	
Source 1	Ch1, Ch2	
Type 1	Minimum, maximum	
Source 2	Ch1, Ch2	
Type 2	Minimum, maximum	

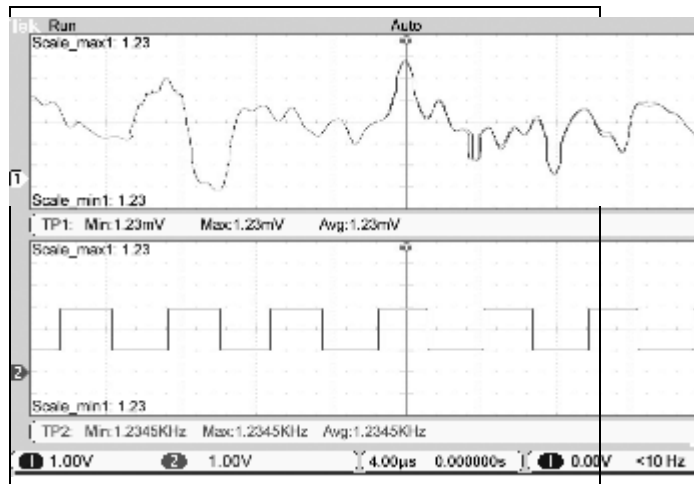

Trigger Controls

You can define the trigger through the Trigger Menu and front-panel controls.

Trigger Types

Three types of triggering are available: Edge, Video, and Pulse Width. A different set of options display for each type of trigger.

Option	Details
Edge (default)	Triggers the oscilloscope on the rising or falling edge of the input signal when it crosses the trigger level (threshold)
Video	Displays NTSC or PAL/SECAM standard composite video waveforms; you trigger on fields or lines of video signals. (See page 98, <i>Video Trigger</i> .)
Pulse	Triggers on aberrant pulses. (See page 99, <i>Pulse Width Trigger</i> .)

Edge Trigger

Use Edge triggering to trigger on the edge of the oscilloscope input signal at the trigger threshold.

Options	Settings	Comments
Edge		With Edge highlighted, the rising or falling edge of the input signal is used for the trigger
Source	Ch1, Ch2, Ext, Ext/5, AC Line	Select the input source as the trigger signal (See page 97.)
Slope	Rising, Falling	Select to trigger on either the rising or falling edge of the signal

Options	Settings	Comments
Mode	Auto, Normal	Select the type of triggering (See page 97.)
Coupling	AC, DC, Noise Reject, HF Reject, LF Reject	Selects the components of the trigger signal applied to the trigger circuitry (See page 98.)

Key Points

Mode Options. The Auto mode (default) forces the oscilloscope to trigger when it does not detect a trigger within a certain amount of time based on the horizontal scale setting. You can use this mode in many situations, such as to monitor the level of a power supply output.

Use the Auto mode to let the acquisition free-run in the absence of a valid trigger. This mode allows an untriggered, scanning waveform at 100 ms/div or slower time base settings.

The Normal mode updates displayed waveforms only when the oscilloscope detects a valid trigger condition. The oscilloscope displays older waveforms until the oscilloscope replaces them with new ones.

Use the Normal mode when you want to see only valid triggered waveforms. When you use this mode, the oscilloscope does not display a waveform until after the first trigger.

To perform a Single Sequence acquisition, push the **Single** button.

Source Options.

Source option	Details
Ch1, Ch2	Triggers on a channel whether or not the waveform is displayed
Ext	Does not display the trigger signal; the Ext option uses the signal connected to the Ext Trig front-panel BNC and allows a trigger level range of +1.6 V to -1.6 V
Ext/5	Same as Ext option, but attenuates the signal by a factor of five, and allows a trigger level range of +8 V to -8 V; this extends the trigger level range
AC Line ¹	Uses a signal derived from the power line as the trigger source; trigger coupling is set to DC and the trigger level to 0 volts. You can use the AC Line when you need to analyze signals related to the frequency of the power line, such as lighting equipment and power supply devices; the oscilloscope automatically generates the trigger, sets the Trigger Coupling to DC, and sets the Trigger Level to zero volts.

¹ Available only when you select the Edge trigger type.

NOTE. To view an Ext, Ext/5, or AC Line trigger signal, push and hold down the **Trigger Menu** button for more than 1.5 seconds to enable trigger view.

Coupling. Coupling allows you to filter the trigger signal used to trigger an acquisition.

Option	Details
DC	Passes all components of the signal
Noise Reject	Adds hysteresis to the trigger circuitry; this reduces sensitivity which reduces the chance of falsely triggering on noise
HF Reject	Attenuates the high-frequency components above 80 kHz
LF Reject	Blocks the DC component and attenuates the low-frequency components below 300 kHz
AC	Blocks DC components and attenuates signals below 10 Hz

NOTE. Trigger coupling affects only the signal passed to the trigger system. It does not affect the bandwidth or coupling of the signal displayed on the screen.

Pretrigger. The trigger position is typically set at the horizontal center of the screen. In this case, you are able to view five divisions of pretrigger information. Adjusting the Horizontal Position of the waveform allows you to see more or less pretrigger information.

Video Trigger

Options	Settings	Comments
Video		With Video highlighted, triggering occurs on an NTSC, PAL, or SECAM standard video signal Trigger coupling is preset to AC
Source	Ch1, Ch2, Ext, Ext/5	Selects the input source as the trigger signal; Ext and Ext/5 selections use the signal applied to the Ext Trig connector
Polarity	Normal, Inverted	Normal triggers on the negative edge of the sync pulse; Inverted triggers on the positive edge of the sync pulse
Sync	All Lines, Line Number, Odd Field, Even Field, All Fields	Select an appropriate video sync Use the multipurpose knob to specify a line number when you select Line Number for the Sync option
Standard	NTSC, PAL/SECAM	Select the video standard for sync and line number count

Key Points

Sync Pulses. When you choose Normal Polarity, the trigger always occurs on negative-going sync pulses. If your video signal has positive-going sync pulses, use the Inverted Polarity selection.

Pulse Width Trigger Use Pulse Width triggering to trigger on normal or aberrant pulses.

Options	Settings	Comments
Pulse		With Pulse highlighted, triggering occurs on pulses that meet the trigger condition defined by the Source, When, and Set Pulse Width options
Source	Ch1, Ch2, Ext, Ext/5	Select the input source as the trigger signal
When	=, ≠, <, >	Select how to compare the trigger pulse relative to the value selected in the Pulse Width option
Pulse Width	33 ns to 10.0 sec	Use the multipurpose knob to set a width
Polarity	Positive, Negative	Select to trigger on positive or negative pulses
Mode	Auto, Normal	Select the type of triggering; Normal mode is best for most Pulse Width trigger applications
Coupling	AC, DC, Noise Reject, HF Reject, LF Reject	Selects the components of the trigger signal applied to the trigger circuitry; (See page 96, <i>Edge Trigger</i> .)
More		Use to switch between submenu pages

Key Points **Trigger When.** The pulse width of the source must be ≥ 5 ns for the oscilloscope to detect the pulse.

When options	Details
=	Triggers the oscilloscope when the signal pulse width is equal to or not equal to the specified pulse width within a $\pm 5\%$ tolerance
≠	
<	Triggers the oscilloscope when the source signal pulse width is less than or greater than the specified pulse width
>	

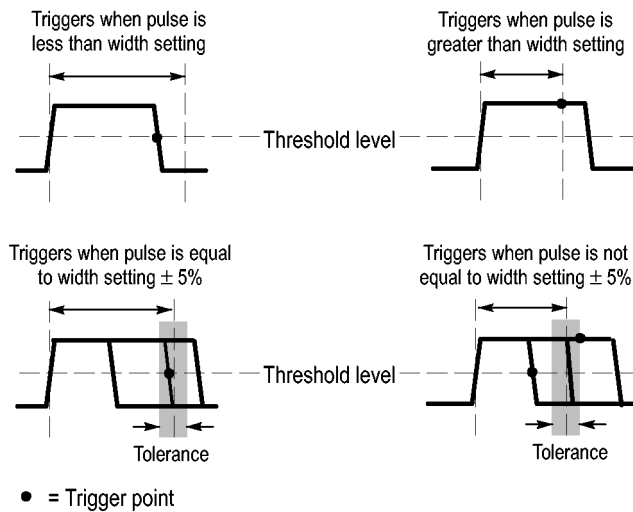

Refer to the *Application Examples* chapter for an example of triggering on aberrant pulses. (See page 39, *Triggering on a Specific Pulse Width*.)

Trigger Frequency Readout

The oscilloscope counts the rate at which triggerable events occur to determine trigger frequency and displays the frequency in the lower right corner of the screen.

NOTE. *The trigger frequency readout shows the frequency of events the oscilloscope might consider to be a trigger, and may be less than the frequency of the input signal in Pulse Width trigger mode.*

Knobs and Buttons

Level Knob. Use to control the Trigger Level.

Push this knob to automatically sets the Trigger Level to be about halfway between the minimum and maximum voltage levels. This can frequently help to quickly stabilize a waveform.

Force Trig Button. Use the **Force Trig** button to complete the waveform acquisition whether or not the oscilloscope detects a trigger. This is useful for single sequence acquisitions and Normal trigger mode. (In Auto trigger mode, the oscilloscope automatically forces triggers periodically if it does not detect a trigger.)

Trigger View. Push the **Trigger Menu** button for more than 1.5 seconds to enable the Trigger View mode and display the conditioned trigger signal on the oscilloscope. You can use this mode to see the following types of information:

- Effects of the Trigger Coupling option
- AC Line trigger source (Edge Trigger only)
- Signal connected to the Ext Trig BNC

Holdoff. You can use the Trigger Holdoff function to produce a stable display of complex waveforms, such as pulse trains. Holdoff is the time between when the oscilloscope detects one trigger and when it is ready to detect another. The oscilloscope will not trigger during the holdoff time. For a pulse train, you can adjust the holdoff time so the oscilloscope triggers only on the first pulse in the train.

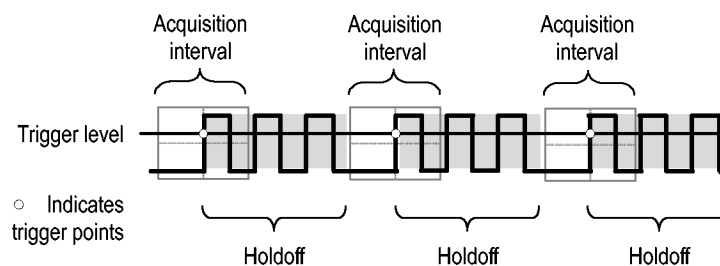

Triggers are not recognized during holdoff time.

To use Trigger Holdoff, push the **Trigger** ► - more - page 1 of 2 ► **Set Trigger Holdoff** option button and use the multipurpose knob to adjust the holdoff. The resolution of the trigger holdoff varies depending on the horizontal scale setting.

Utility

Push the **Utility** button to display the Utility Menu.

EDU-models:

Options	Settings	Comments
Display	Type (Vectors, Dots), Persist (1 sec, 2 sec, 5 sec, Infinite, Off), Format (YT, XY), Backlight (1% to 100%)	
Language	English, French, German, Italian, Spanish, Japanese, Portuguese, Simplified Chinese, Traditional Chinese, Korean	Selects the display language of the oscilloscope
Do Self Cal		Performs a self calibration
Probe check		

Options	Settings	Comments
File Utilities		Displays folder, file, and USB flash drive options (See page 104.)
Options	Rear USB Port (auto detect, printer, computer), printer setup, GPIB setup, Set date and time, error log	
Update course		
Autoset Enable	Enable, Disable Change Password	To further enhance the teaching process on EDU oscilloscopes, you (the teacher) can disable the Autoset function. For those beginning labs where it is important for a student to learn the basic operation of the scope, disabling Autoset will help them apply their knowledge of oscilloscope operation instead of taking shortcuts with the Autoset button
System Status	Horizontal, vertical, trigger, miscellaneous	

Non-EDU-models:

Options	Settings	Comments
Display	Type (Vectors, Dots), Persist (1 sec, 2 sec, 5 sec, Infinite, Off), Format (YT, XY), Backlight (1% to 100%)	
Language	English, French, German, Italian, Spanish, Japanese, Portuguese, Simplified Chinese, Traditional Chinese, Korean	Selects the display language of the oscilloscope
Do Self Cal		Performs a self calibration
Probe check		
File Utilities		Displays folder, file, and USB flash drive options (See page 104.)
Options	Rear USB Port (auto detect, printer, computer), printer setup, GPIB setup, Set date and time, error log	
System Status	Horizontal, vertical, trigger, miscellaneous	

Display	Settings	Comments
Type	Vectors or Dots	
Persistence	1 second, 2 seconds, 5 seconds, infinite, or off	
Format	YT or XY	YT is the normal oscilloscope mode of operation. It displays voltage (vertically) versus time (horizontally). XY displays channel 1's voltage versus channel 2's voltage.
Backlight		

File Utilities	Settings	Comments
Change Folder		
New Folder		
Delete		
Rename		Change the name of a file on the attached USB flash drive.
Format		Format the attached USB flash drive. It will erase all files on the drive.
Update Firmware		

Options	Settings	Comments
System Status		Summary of the oscilloscope settings
	Misc.	Displays model, manufacturer serial number, adapters connected, GPIB setup address, firmware version, and other information
Options	Rear USB Port: Computer, Auto, Detect, Printer	
	Printer Setup	Changes the output setup
	GPIB Setup ► Address	Sets the GPIB address for the TEK-USB-488 adapter (See page 67.)
	Set Date and Time	Sets the date and time (See page 104.)
	Error Log	Displays a list of any errors logged and the Power Cycle count This log is useful if you contact a Tektronix Service Center for help.

Key Points **System Status.** Selecting System Status from the Utility Menu displays the menus available for obtaining a list of control settings for each group of oscilloscope controls.

Push any front-panel menu button to remove the status screen.

Options	Comments
Horizontal	Lists horizontal parameters
Vertical	Lists vertical parameters of channels

Options	Comments
Trigger	Lists trigger parameters
Misc	Lists the model of the oscilloscope, the version number of the software, and the serial number Lists values of the communications parameters

Setting the Date and Time. You can use the Set Date and Time menu to set the clock date and time. The oscilloscope displays this information, and also uses it to time stamp files written to a USB flash drive. The oscilloscope contains a built-in nonreplaceable battery to maintain the clock settings.

The clock does not automatically adjust for seasonal time changes. The calendar does adjust for Leap years.

Options	Comments
Date	Push the side-menu button and turn and push the multipurpose knob to set the day, month, and year.
Time	Push the side-menu button and turn and push the multipurpose knob to set the hour and minute.

Self Calibration. The self calibration routine optimizes the oscilloscope accuracy for the ambient temperature. For maximum accuracy, perform a self cal if the ambient temperature changes by 5 °C (9 °F) or more. For accurate calibration, power on the oscilloscope and wait twenty minutes to ensure it is warmed up. Follow the directions on the screen.

Factory calibration uses externally-generated voltages, and requires specialized equipment. The recommended interval is one year. See *Contacting Tektronix* on the copyright page for information on having Tektronix perform a Factory Calibration of your oscilloscope.

File Utilities for the USB Flash Drive

One folder is always designated as the current folder. The current folder is the default location to save and recall files.

You can use the File Utilities menu to do the following tasks:

- List the contents of the current folder
- Select a file or folder
- Navigate to other folders
- Create, rename, and delete files and folders
- Format a USB flash drive

Options	Comments
Change Folder	Navigates to the selected USB flash drive folder. Use the multipurpose knob to select a file or folder, then select the Change Folder menu option. To return to the previous folder, select the ↑Up folder item and then select the Change Folder menu option.
New Folder	Creates a new folder in the current folder location, named NEW_FOL, and displays the Rename menu for changing the default folder name.
Rename (filename or folder)	Displays the Rename screen to rename a folder or file, described next.
Delete (filename or folder)	Deletes the selected file name or folder; a folder must be empty before you can delete it.
Confirm Delete	Displays after pressing Delete, to confirm a file delete action. Pressing any button or knob other than Confirm Delete cancels the file delete action.
Format	Formats the USB flash drive; this deletes all data on the USB flash drive.
Update Firmware	Follow the on-screen directions to set up and push the Update Firmware option button to start updating firmware.

Rename File or Folder. You can change the names of files and folders on a USB flash drive.

Option	Settings	Comments
Enter Character	A - Z, 0 - 9, _, .	Enters the highlighted alphanumeric character at the current Name field cursor position Use the multipurpose knob to select an alphanumeric character or the Backspace, Delete Character, or Clear Name functions
	Backspace	Changes the menu button 1 option to the Backspace function. Deletes the character to the left of the highlighted character in the Name field
	Delete Character	Changes the menu button 1 option to the Delete Character function. Deletes the highlighted character from the Name field
	Clear Name	Changes the menu button 1 option to Clear Name. Deletes all characters from the Name field

Vertical Controls

You can use the vertical controls to display and remove waveforms, adjust vertical scale and position, set input parameters, and for vertical math operations. (See page 84, *Math*.)

Channel Vertical Menus

There is a separate vertical menu for each channel. Each option is set individually for each channel.

Options	Settings	Comments
Coupling	DC, AC, Ground	DC passes both AC and DC components of the input signal AC blocks the DC component of the input signal and attenuates signals below 10 Hz Ground disconnects the input signal

Options	Settings	Comments
BW Limit	20 MHz ¹ , Off	Limits the bandwidth to reduce display noise; filters the signal to reduce noise and other unwanted high frequency components
Volts/Div	Coarse, Fine	Selects the resolution of the Scale (Volts/Div) knob Coarse defines a 1-2-5 sequence. Fine changes the resolution to small steps between the coarse settings
Probe	See the next table	Push to adjust Probe options
Invert	On, Off	Inverts (flips) the waveform with respect to the reference level

¹ Effective bandwidth is 6 MHz with a P2220 probe set to 1X.

The option for voltage and current probes is different: Attenuation or Scale.

Probe options	Settings	Comments
Probe ► Voltage ► Attenuation	1X, 10X, 20X, 50X, 100X, 500X, 1000X	Set to match the attenuation factor of the voltage probe to ensure correct vertical readouts
Probe ► Current ► Scale	5 V/A, 1 V/A, 500 mV/A, 200 mV/A, 100 mV/A, 20 mV/A, 10 mV/A, 1 mV/A	Set to match the scale of the current probe to ensure correct vertical readouts
Back		Returns to the previous menu

Knobs

Vertical Position Knobs. Use the **Vertical Position** knobs to move the channel waveforms up or down on the screen.

Vertical Scale (volts/division) Knobs. Use the **Vertical Scale** knobs to control how the oscilloscope amplifies or attenuates the source signal of channel waveforms. When you turn a **Vertical Scale** knob, the oscilloscope increases or decreases the vertical size of the waveform on the screen.

Vertical Measurement Overrange (Clipping). A display of ? in the measurement readout indicates an invalid value. This may be due to waveforms that extend beyond the screen (overrange). Adjust the vertical scaling to ensure the readout is valid.

Key Points

Ground Coupling. Use Ground coupling to display a zero-volt waveform. Internally, the channel input is connected to a zero-volt reference level.

Fine Resolution. The vertical scale readout displays the actual volts/division setting while in the fine resolution setting. Changing the setting to coarse does not change the vertical scale until the **Vertical Scale** control is adjusted.

Remove Waveform. To remove a waveform from the display, push a channel menu front panel button. For example, push the **1** (channel 1 menu) button to display or remove the channel 1 waveform.

NOTE. *You do not have to display a channel waveform to use it as a trigger source or for math operations.*

NOTE. *You must display a channel waveform to take measurements from it, use cursors on it, or to save it as a Reference waveform or to a file.*

Zoom Controls

Push the **Zoom** button to display a zoomed-in waveform in about three-quarters of the screen. The original waveform will continue to be displayed in about one-quarter of the screen. The zoomed in waveform magnifies a waveform horizontally. Also, use the zoom button to scroll through a zoomed waveform.

Push the Multipurpose knob to enable the knob to either search through the waveform or zoom in or out on the waveform.

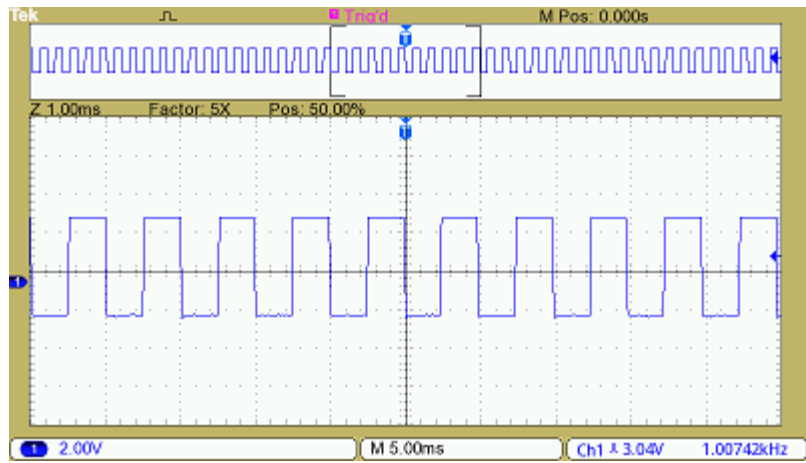

Appendix A: Specifications

You can find a more complete list of TBS1000B and TBS1000B-EDU product specifications in the TBS1000B and TBS1000B-EDU Series Oscilloscopes Service Manual.

Oscilloscope Specifications

Table 1: Model overview

	TBS1052B/EDU	TBS1072B/EDU	TBS1102B/EDU	TBS1152B/EDU	TBS1202B/EDU
Bandwidth	50 MHz	70 MHz	100 MHz	150 MHz	200 MHz
Channels	2	2	2	2	2
Sample rate of each channel	1.0 GS/s	1.0 GS/s	2.0 GS/s	2.0 GS/s	2.0 GS/s
Record length	2.5k points at all time bases				

Table 2: Vertical system — Analog channels

Characteristic	Description
Vertical resolution	8 bits
Input sensitivity range	2 mV to 5 V/div on all models with calibrated fine adjustment
DC gain accuracy	±3% from 10 mV/div to 5 V/div
Maximum input voltage	300 V _{RMS} CAT II; derated at 20 dB/decade above 100 kHz to 13 V _{pp} AC at 3 MHz
Offset range	2 mV to 200 mV/div; at 1.8 V >200 mV to 5 V/div; ±45 V
Bandwidth limit	20 MHz
Input coupling	AC, DC, Ground
Input impedance	1 MΩ in parallel with 20 pF
Vertical zoom	Vertically expand or compress a live or stopped waveform

Table 3: Horizontal system — Analog channels

Characteristic	Description
Time base range	5 ns to 50 s/div
Time base accuracy	50 ppm
Horizontal zoom	Horizontally expand or compress a live or stopped waveform

Table 4: Input/Output ports

Characteristic	Description
USB interface	USB host port on the front panel supports USB flash drives. USB device port on the back of the instrument supports connection to a PC.
GPIB interface	Optional

Table 5: Data storage — nonvolatile

Characteristic	Description
Reference waveform display	2.5k point reference waveforms
Waveform storage without USB flash drive	2.5k points
Maximum USB flash drive size	64 GB
Waveform storage with USB flash drive	96 or more reference waveforms per 8 MB
Setups without USB flash drive	10 front-panel setups
Setups with USB flash drive	4,000 or more front-panel setups per 8 MB
Screen images with USB flash drive	128 or more screen images per 8 MB (the number of images depends on the file format selected)
Save All with USB flash drive	12 or more screen images per 8 MB A single Save All operation creates 3 to 9 files (setup, image, plus one file for each displayed waveform)
Course content (EDU models)	100 MB

Table 6: Acquisition system

Characteristic	Description
Peak Detect	High-frequency and random glitch capture. Captures glitches as narrow as 12 ns (typical) at all time base settings from 5 μ s/div to 50 s/div
Sample	Sample data only
Average	Waveform averaged, selectable: 4, 16, 64, 128
Single Sequence	Use the Single Sequence button to capture a single triggered acquisition sequence
Roll	At acquisition time base settings of >100 ms/div

Table 7: Trigger system

Characteristic	Description
External trigger input	Included on all models
Trigger modes	Auto, Normal, Single Sequence
Trigger types	Edge: (Rising/Falling): Conventional level-driven trigger. Positive or negative slope on any channel. Coupling selections: AC, DC, Noise Reject, HR Reject, LF Reject Video: Trigger on all lines or individual lines, odd/even or all fields from composite video, or broadcast standards (NTSC, PAL, SECAM) Pulse Width (or Glitch): Trigger on a pulse width less than, greater than, equal to, or not equal to, a selectable time limit ranging from 33 ns to 10 s.
Trigger source	Two channel models: Ch1, Ch2, Ext, Ext/5, AC Line
Trigger view	Displays the trigger signal while the Trigger View button is depressed
Trigger signal frequency readout	Provides a frequency readout of the trigger source

Table 8: Waveform measurements

Characteristic	Description
Cursors	Types: Amplitude, Time Measurements: ΔT , $1/\Delta T$, ΔV
Automatic measurements	Period, Frequency, Pos Width, Neg Width, Rise Time, Fall Time, Maximum, Minimum, Peak-Peak, Mean, RMS, Cycle RMS, Cursor RMS, Phase, Pos Pulse Cnt, Neg Pulse Cnt, Rise Edge Cn, Fall Edge Cn, Pos Duty, Neg Duty, Amplitude, Cycle Mean, Cursor Mean, Burst Width, Pos Overshoot, Neg Overshoot, Area, Cycle Area, High, Low, Delay RR, Delay RF, Delay FR, Delay FF

Table 9: Waveform math

Characteristic	Description
Arithmetic	Add, Subtract, Multiply
Math functions	FFT
FFT	Windows: Hanning, Flat Top, Rectangular. 2,048 sample points.
Sources	Ch1 – Ch2, Ch2 – Ch1, Ch1 + Ch2, Ch1 * Ch2

Table 10: Autoset

Characteristic	Description
Autoset menu	Single-button, automatic setup of all channels for vertical, horizontal, and trigger system, with undo Autoset
Square wave	Single Cycle, Multicycle, Rising or Falling Edge
Sine wave	Single Cycle, Multicycle, FFT Spectrum
Video (NTSC, PAL, SECAM)	Field: All, Odd, or Even Line: All or Selectable Line Number

Table 11: Autorange

Characteristic	Description
Autorange	Automatically adjust vertical and/or horizontal oscilloscope settings when the probe is moved from point to point, or when the signal exhibits large changes.

Table 12: Frequency counter

Characteristic	Description
Resolution	6 digits
Accuracy (typical)	+51 parts per million including all frequency reference errors and +1 count errors
Frequency range	AC coupled, 10 Hz minimum to rated bandwidth
Frequency counter signal source	Pulse width or edge selected trigger source. Frequency counter measures selected trigger source at all times in pulse width and edge mode, including when the oscilloscope acquisition is halted due to changes in run status, or acquisition of a single shot event has completed. The frequency counter does not measure pulses that do not qualify as legitimate trigger events. Pulse Width mode: Counts pulses of enough magnitude inside the 250 ms measurement window that qualify as triggerable events (e.g. all narrow pulses in a PWM pulse train if set to "<" mode and the limit is set to a relatively small number). Edge Trigger mode: Counts all pulses of enough magnitude.

Table 13: Display system

Characteristic	Description
Interpolation	Sin (x)/x
Waveform styles	Dots, vectors
Persistence	Off, 1 s, 2 s, 5 s, infinite
Format	YT or XY

Table 14: Courseware software: minimum requirements needed to install the Courseware software

Characteristic	Description
Operating System	Windows XP, Windows 7, Windows 8, Linux (Ubuntu 12.04, 12.10, 13.04 or Fedora 18, 19)
RAM	512 Megabytes (MB)
Disk space	1 Gigabyte of available hard disk space
Display	XVGA 1024 * 768 with 120 dpi font size recommended
Removable media	CD-ROM or EVE drive
Peripherals	Keyboard and Microsoft mouse or other compatible pointing device

Table 15: Physical characteristics

		mm	inches
Dimensions	Height	158.0	6.22
	Width	326.3	12.85
	Depth	124.2	4.89
		mm	inches
Shipping dimensions	Height	266.7	10.5
	Width	476.2	18.75
	Depth	228.6	9.0
		kg	lb.
Weight	Instrument only	2.0	4.4
	Instrument with accessories	2.2	4.9
		mm	inches
RM2000B rackmount	Width	482.6	19.0
	Height	177.8	7.0
	Depth	108.0	4.25

Table 16: Environmental

Characteristic	Description
Temperature	Operating: 0 to +50 °C Non-operating: -40 to +71 °C
Humidity	Operating and non-operating: Up to 85% relative humidity (RH) at or below +40 °C Up to 45% RH at or below +50 °C
Altitude	Operating and non-operating: Up to 3,000 m (9,843 feet)

Appendix B: TPP0051, TPP0101 and TPP0201 Series 10X Passive Probes Information

The TPP0051, TPP0101 & TPP0201 Series 10X Passive Probes are high impedance, passive probes with 10X attenuation. They are designed for use with TBS1000B oscilloscopes. These oscilloscopes have 20 pF of input capacitance.

The compensation range of these probes is 15 – 25 pF.

The probes have no user- or Tektronix-serviceable parts.



WARNING. Do not float the TPP0051, TPP0101 and TPP0201 probes on any oscilloscope.

Connecting the Probe to the Oscilloscope

Connect the probe as shown in the illustrations below.

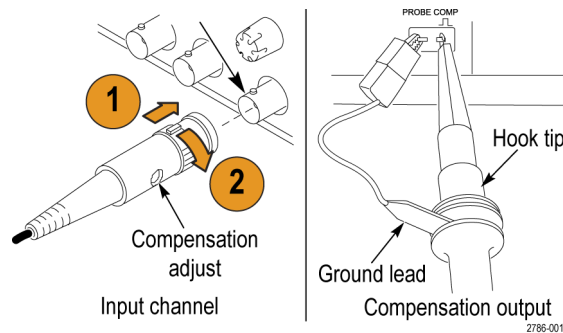

Compensating the Probe

Due to variations in oscilloscope input characteristics, the low-frequency compensation of the probe may need adjustment after moving the probe from one oscilloscope channel to another.

If a 1 kHz calibrated square wave displayed at 1 ms/division shows significant differences between the leading and trailing edges, perform the following steps to optimize low-frequency compensation:

1. Connect the probe to the oscilloscope channel that you plan to use for your measurements.
2. Connect the probe to the probe compensation output terminals on the oscilloscope front panel.



WARNING. To avoid electric shock, only connect to the Probe Comp signal on the oscilloscope when making this adjustment.

3. Push **Autoset** or otherwise adjust your oscilloscope to display a stable waveform.
4. Adjust the trimmer in the probe until you see a perfectly flat-top square wave on the display. (See illustration.)



WARNING. To avoid electric shock, only use the insulated adjustment tool when making compensation adjustments.

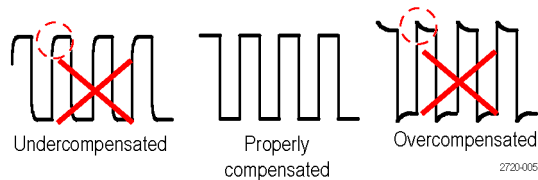

Connecting the Probe to the Circuit

Use the standard accessories included with the probe to connect to your circuit.



WARNING. To avoid electric shock when using the probe or accessories, keep fingers behind the finger guard of the probe body and accessories.

To reduce risk of shock, ensure the ground lead and ground spring are fully mated before connecting the probe to the circuit under test.

Standard Accessories

The accessories included with the probe are shown below.

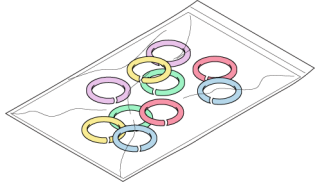
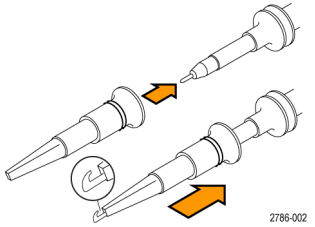
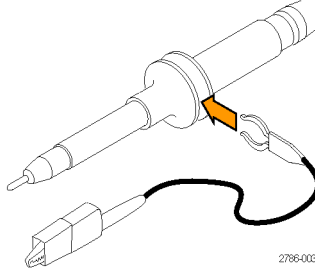
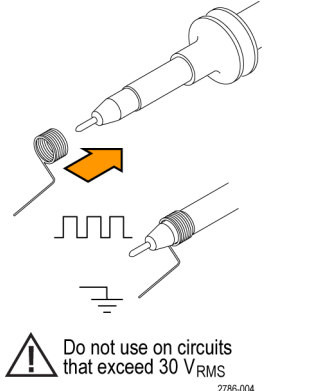
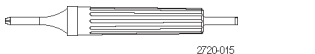
Item	Description
	<p>Color bands</p> <p>Use these bands to identify the oscilloscope channel at the probe head.</p> <p>Reorder Tektronix part number 016-0633-xx (5 pairs)</p>
 <p style="text-align: right; font-size: small;">2786-002</p>	<p>Hook tip</p> <p>Press the hook tip onto probe tip and then clamp the hook onto the circuit.</p> <p>Reorder Tektronix part number 013-0362-xx</p>
 <p style="text-align: right; font-size: small;">2786-003</p>	<p>Ground lead, with alligator clip</p> <p>Secure the lead to the probe head ground and then to your circuit ground.</p> <p>Reorder Tektronix part number 196-3521-xx</p>
 <p style="text-align: right; font-size: small;">2786-004</p> <p>⚠ Do not use on circuits that exceed 30 V_{RMS}</p>	<p>Ground spring</p> <p>The ground spring minimizes aberrations on high-frequency signals caused by the inductance of the ground path, giving you measurements with good signal fidelity.</p> <p>Attach the spring to the ground band on the probe tip. You can bend the spring out to ~0.75 in. away from the signal test point.</p> <p>Reorder Tektronix part number 016-2028-xx (2 ea.)</p>
 <p style="text-align: right; font-size: small;">2720-015</p>	<p>Adjustment tool</p> <p>Reorder Tektronix part number 003-1433-xx</p>

Optional Accessories

You can order the following accessories for your probe.

Accessory	Part number
Alligator Ground Lead, 12 in	196-3512-xx
6" Clip-on Ground Lead	196-3198-xx
Ground Spring, Short, 2 ea.	016-2034-xx
MicroCKT Test Tip	206-0569-xx
Micro Hook Tip	013-0363-xx
Universal IC Cap	013-0366-xx
Circuit Board Test Point/PCB Adapter	016-2016-xx
Wire, spool, 32 AWG	020-3045-xx

Specifications

Table 17: Electrical and mechanical specifications

Characteristic	TPP0051	TPP0101	TPP0201
Bandwidth (-3 dB)	DC to 50 MHz	DC to 100 MHz	DC to 200 MHz
System attenuation accuracy	10:1 \pm 3.2%	10:1 \pm 3.2%	10:1 \pm 3.2%
Compensation range	15 pF – 25 pF	15 pF – 25 pF	15 pF – 25 pF
System input resistance @ DC	10 M Ω \pm 1.5%	10 M Ω \pm 1.5%	10 M Ω \pm 1.5%
System input capacitance	<12 pF	<12 pF	<12 pF
System rise time (typical)	<3.5 ns	<3.5 ns	<2.3 ns
Propagation delay	~6.1 ns	~6.1 ns	~6.1 ns
Maximum input voltage	300 V _{RMS} CAT II	300 V _{RMS} CAT II	300 V _{RMS} CAT II
Cable length	1.3 m	1.3 m	1.3 m

Table 18: Environmental specifications

Characteristics	Description
Temperature	
Operating	-10 °C to +55 °C (14 °F to +131 °F)
Nonoperating	-51 °C to +71 °C (-60 °F to +160 °F)
Humidity	
Operating and Non-Operating	5% to 95% relative humidity (%RH) up to +30 °C (86 °F), 5% to 65% RH above +30° C up to +55 °C (131 °F)
Altitude	
Operating	3.0 km (10,000 ft) maximum
Nonoperating	12.2 km (40,000 ft) maximum

Performance Graphs

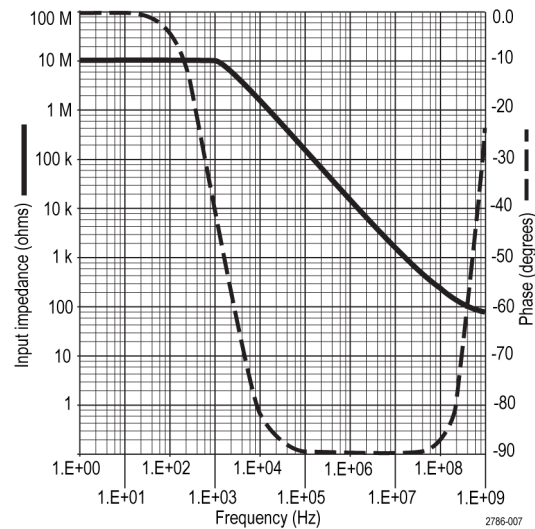
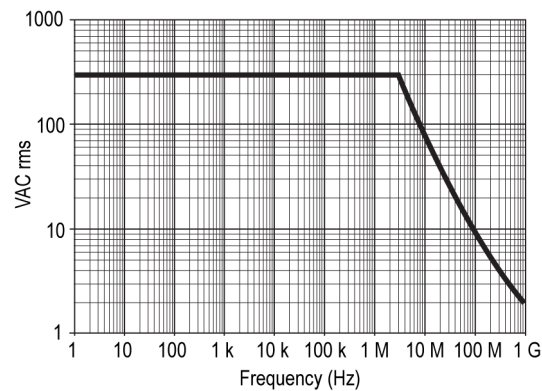

Table 19: Certifications and compliances

Characteristics	Description								
EC Declaration of Conformity	Compliance was demonstrated to the following specification as listed in the Official Journal of the European Communities: Low Voltage Directive 2006/95/EC: EN61010-031: 2002								
Safety Standards	UL61010-031;2007 CAN/CSA C22.2 No. 61010-031-07 IEC61010-031; IEC 61010-031/A1:2008								
Measurement Category Descriptions	<table border="1"> <thead> <tr> <th>Category</th> <th>Examples of Products in this Category</th> </tr> </thead> <tbody> <tr> <td>CAT III</td> <td>Distribution-level mains, fixed installation</td> </tr> <tr> <td>CAT II</td> <td>Local-level mains, appliances, portable equipment</td> </tr> <tr> <td>CAT I</td> <td>Circuits not directly connected to mains.</td> </tr> </tbody> </table>	Category	Examples of Products in this Category	CAT III	Distribution-level mains, fixed installation	CAT II	Local-level mains, appliances, portable equipment	CAT I	Circuits not directly connected to mains.
Category	Examples of Products in this Category								
CAT III	Distribution-level mains, fixed installation								
CAT II	Local-level mains, appliances, portable equipment								
CAT I	Circuits not directly connected to mains.								
Pollution Degree 2	Do not operate in environments where cond- uctive pollutants may be present (as defined in IEC 61010-1). Rated for indoor use only.								



Equipment Recycling. This product complies with the European Union's requirements according to Directive 2002/96/EC on waste electrical and electronic equipment (WEEE). For more information about recycling options, check the Support/Service section of the Tektronix Web site (www.tektronix.com).

Safety Summary

Review the following safety precautions to avoid injury and prevent damage to this product or any products connected to it. To avoid potential hazards, use this product only as specified. Using the probe or accessories in a manner not specified could result in a shock or fire hazard.

To Avoid Fire or Personal Injury

Ground-Referenced Oscilloscope Use. Do not float the reference lead of this probe when using with ground referenced oscilloscopes (for example, TBS series oscilloscopes). The reference lead must be connected to earth potential (0 V).

Connect and Disconnect Properly. Connect the probe output to the measurement instrument before connecting the probe to the circuit under test. Disconnect the probe input and the probe reference lead from the circuit under test before disconnecting the probe from the measurement instrument.

Avoid Electric Shock. Do not connect or disconnect probes or test leads while they are connected to a voltage source.

Observe All Terminal Ratings. To avoid fire or shock hazard, observe all ratings and markings on the product. Consult the product manual for further ratings information before making connections to the product.

Avoid Electric Shock. When using probe accessories, never exceed the lowest rating of the probe or its accessory, whichever is less, including the measurement category and voltage rating.

Inspect the Probe and Accessories. Before each use, inspect the probe and accessories for damage (cuts, tears, defects in the probe body, accessories, cable jacket, etc.). Do not use if damaged.

Do Not Operate in Wet/Damp Conditions.

Do Not Operate in an Explosive Atmosphere.

Keep Product Surfaces Clean and Dry.

**Safety Terms and Symbols
Terms in This Manual.**

These terms may appear in this manual:



WARNING. *Warning statements identify conditions or practices that could result in injury or loss of life.*



CAUTION. *Caution statements identify conditions or practices that could result in damage to this product or other property.*

Symbols on the Product. These symbols may appear on the product:



Caution
Refer to Manual



Earth Terminal

Appendix C: Accessories

All accessories (standard and optional) are available by contacting your local Tektronix field office.

Standard Accessories

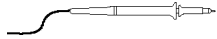

TPP0051 (TBS1052B and TBS1052B-EDU) 10X Passive Voltage Probe,

The TPP0051 probes have a system bandwidth of DC to 50 MHz at -3 dB and ship standard with TBS1000B oscilloscope models that have bandwidths up to 50 MHz.

TPP0101 (TBS1072B, TPS1072B-EDU, TBS1102B, TBS1102B-EDU) 10X Passive Voltage Probe,

The TPP0101 probes have a system bandwidth of DC to 100 MHz at -3 dB and ship standard with TBS1000B oscilloscope models that have bandwidths up to 100 MHz.

TPP0201 (TBS1152B, TBS1152B-EDU, TBS1202B, TBS1202B-EDU) 10X Passive Voltage Probe.

The TPP0201 probes have a system bandwidth of DC to 200 MHz at -3 dB and ship standard with TBS1000B models with bandwidths greater than 100 MHz.

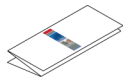

TBS1000B Oscilloscope Compliance and Safety Instructions. (English, Japanese, Simplified Chinese) (071-3223-XX) A single printed document is included. Refer to the Optional Accessories for a complete list of available language manuals.

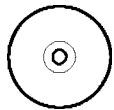

Customer Documentation Browser CD-ROM. This CD offers additional product information (063-4512-XX).

Power cord

Specify plug option

NIM/NIST

Traceable certificate of calibration

5-year warranty

Covers labor and parts for defects in materials and workmanship for 5 years, excluding probes and accessories. Probes and accessories are not covered by the oscilloscope warranty and service offerings. Refer to the data sheet of each probe and accessory model for its unique warranty and calibration terms.

Optional Accessories



P6101B 1X Passive Voltage Probe. The P6101B probe has a 15 MHz bandwidth with a rating of 300 V_{RMS} CAT II.

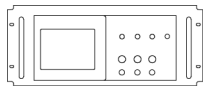

RM2000B Rackmount Kit. The RM2000B Rackmount Kit lets you install a TBS1000B series oscilloscope into an industry-standard 19 inch rack. The rackmount kit requires seven inches (18 cm) of vertical rack space. You can turn the oscilloscope power on or off from the front of the rackmount kit. The rackmount kit does not have slide-out capability.

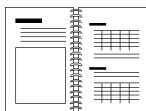

TBS1000B, TBS1000B-EDU, TDS2000C and TPS2000 Series Digital Oscilloscopes Programmer Manual. The PDF programmer manual (077-0444-XX, English) provides command and syntax information.



TBS1000B and TBS1000B-EDU Series Digital Storage Oscilloscope Service Manual. The PDF service manual (077-0897-XX, English) provides module-level repair information.

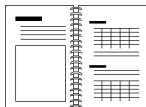

TBS1000B and TBS1000B-EDU Series Digital Storage Oscilloscope User Manuals. The PDF user manual is available in these languages:

- English, 077-0886-XX
- French, 077-0887-XX
- Italian, 077-0888-XX
- German, 077-0889-XX
- Spanish, 077-0890-XX
- Japanese, 077-0891-XX
- Portuguese, 077-0892-XX
- Simplified Chinese, 077-0893-XX
- Traditional Chinese, 077-0894-XX
- Korean, 077-0895-XX
- Russian, 077-0896-XX

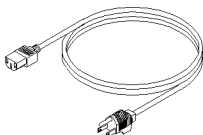

International Power Cords. In addition to the power cord shipped with your oscilloscope, you can obtain the following cords:

- Option A0, North American 120 V, 60 Hz, 161-0066-00
- Option A1, European 230 V, 50 Hz, 161-0066-09
- Option A2, United Kingdom 230 V, 50 Hz, 161-0066-10
- Option A3, Australian 240 V, 50 Hz, 161-0066-13
- Option A5, Switzerland 230 V, 50 Hz, 161-0154-00
- Option A6, Japan 100 V, 50/60 Hz, 161-0342-00
- Option A10, China 220 V, 50 Hz, 161-0304-00
- Option A11, India 230 V, 50 Hz, 161-0400-00
- Option A12, Brazil 127/220 V, 60 Hz, 161-0357-00

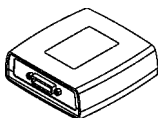

TEK-USB-488 Adapter. The GPIB adapter allows you to connect your oscilloscope to a GPIB controller.



Soft Case. The soft case (AC2100) protects the oscilloscope from damage and provides space for probes, a power cord, and manuals.

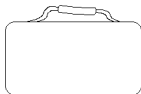

Transit Case. The transit case (HCTEK4321) provides shock, vibration, impact and moisture protection for the oscilloscope when you transport it from one place to another. The required soft case fits inside the transit case.

Appendix D: Cleaning

General Care

Do not store or leave the oscilloscope where the LCD display will be exposed to direct sunlight for long periods of time.



CAUTION. *To avoid damage to the oscilloscope or probes, do not expose them to sprays, liquids, or solvents.*

Cleaning

Inspect the oscilloscope and probes as often as operating conditions require. To clean the exterior surface, perform the following steps:

1. Remove loose dust on the outside of the oscilloscope and probes with a lint-free cloth. Use care to avoid scratching the clear glass display filter.
2. Use a soft cloth dampened with water to clean the oscilloscope. Use an aqueous solution of 75% isopropyl alcohol for more efficient cleaning.



CAUTION. *To avoid damage to the surface of the oscilloscope or probes, do not use any abrasive or chemical cleaning agents.*

Appendix E: Default Setup

This appendix describes the options, buttons and controls that change settings when you push the **Default Setup** button. The last page of this appendix lists settings that do not change.

NOTE. When you push the **Default Setup** button, the oscilloscope displays the channel 1 waveform and removes all other waveforms.

Menu or system	Option, button, or knob	Default setting
Acquire	(three mode options)	Sample
	Averages	16
	Run/Stop	Run
Autorange	Autorange	Off
	Mode	Vertical and Horizontal
Cursor	Type	Off
	Source	Ch1
Display	Type	Vectors
	Persist	Off
	Format	YT
	Backlight	60%
FFT	Source	Ch1
	Window	Hanning
	FFT Zoom	X1
Horizontal	Position	0.00 s
	Scale (seconds/division)	500 μ s
Math	Operation	-
	Sources	Ch1 - Ch2
	Position	0 divs
	Vertical Scale	2 V
Measure (all)	Source	Ch1
	Type	None
Trigger	Type	Edge
	Source	Ch1
	Slope	Rising
	Mode	Auto
	Coupling	DC
	Holdoff	500.0 ns

Menu or system	Option, button, or knob	Default setting
Vertical system, all channels	Coupling	DC
	BW Limit	Off
	Vertical scale (volts/division)	Coarse
	Probe	Voltage
	Voltage Probe Attenuation	10X
	Current Probe Scale	10 A/V
	Invert	Off
	Position	0.00 divs (0.00 V)
	Scale (volts/division)	1.00 V

The **Default Setup** button does not reset the following settings:

- Language option
- Saved setups
- Saved reference waveforms
- Calibration data
- GPIB setup
- Probe setup (type and attenuation factor)
- Date and time
- Current folder on the USB flash drive

Appendix F: Font Licenses

The following license agreements cover Asian fonts used in the TBS1000B series oscilloscopes.

Copyright © 1988 The Institute of Software, Academia Sinica.

Correspondence Address: P.O.Box 8718, Beijing, China 100080.

Permission to use, copy, modify, and distribute this software and its documentation for any purpose and without fee is hereby granted, provided that the above copyright notices appear in all copies and that both those copyright notices and this permission notice appear in supporting documentation, and that the name of "the Institute of Software, Academia Sinica" not be used in advertising or publicity pertaining to distribution of the software without specific, written prior permission. The Institute of Software, Academia Sinica, makes no representations about the suitability of this software for any purpose. It is provided "as is" without express or implied warranty.

THE INSTITUTE OF SOFTWARE, ACADEMIA SINICA, DISCLAIMS ALL WARRANTIES WITH REGARD TO THIS SOFTWARE, INCLUDING ALL IMPLIED WARRANTIES OF MERCHANTABILITY AND FITNESS, IN NO EVENT SHALL THE INSTITUTE OF SOFTWARE, ACADEMIA SINICA, BE LIABLE FOR ANY SPECIAL, INDIRECT OR CONSEQUENTIAL DAMAGES OR ANY DAMAGES WHATSOEVER RESULTING FROM LOSS OF USE, DATA OR PROFITS, WHETHER IN AN ACTION OF CONTRACT, NEGLIGENCE OR OTHER TORTIOUS ACTION, ARISING OUT OF OR IN CONNECTION WITH THE USE OR PERFORMANCE OF THIS SOFTWARE.

© Copyright 1986-2000, Hwan Design Inc.

You are hereby granted permission under all Hwan Design propriety rights to use, copy, modify, sublicense, sell, and redistribute the 4 Baekmuk truetype outline fonts for any purpose and without restriction; provided, that this notice is left intact on all copies of such fonts and that Hwan Design Int.'s trademark is acknowledged as shown below on all copies of the 4 Baekmuk truetype fonts.

BAEKMUK BATANG is a registered trademark of Hwan Design Inc.
BAEKMUK GULIM is a registered trademark of Hwan Design Inc. BAEKMUK DOTUM is a registered trademark of Hwan Design Inc. BAEKMUK HEADLINE is a registered trademark of Hwan Design Inc.

© Copyright 2000-2001 /efont/ The Electronic Font Open Laboratory. All rights reserved.

Redistribution and use in source and binary forms, with or without modification, are permitted provided that the following conditions are met:

- Redistribution of source code must retain the above copyright notice, this list of conditions and the following disclaimer.
- Redistributions in binary form must reproduce the above copyright notice, this list of conditions and the following disclaimer in the documentation and/or other materials provided with the distribution.
- Neither the name of the team nor the names of its contributors may be used to endorse or promote products derived from this font without specific prior written permission.

THIS FONT IS PROVIDED BY THE TEAM AND CONTRIBUTORS "AS IS" AND ANY EXPRESS OR IMPLIED WARRANTIES, INCLUDING, BUT NOT LIMITED TO, THE IMPLIED WARRANTIES OF MERCHANTABILITY AND FITNESS FOR A PARTICULAR PURPOSE ARE DISCLAIMED. IN NO EVENT SHALL THE TEAM OR CONTRIBUTORS BE LIABLE FOR ANY DIRECT, INDIRECT, INCIDENTAL, SPECIAL, EXEMPLARY, OR CONSEQUENTIAL DAMAGES (INCLUDING, BUT NOT LIMITED TO, PROCUREMENT OF SUBSTITUTE GOODS OR SERVICES; LOSS OF USE, DATA, OR PROFITS; OR BUSINESS INTERRUPTION) HOWEVER CAUSED AND ON ANY THEORY OF LIABILITY, WHETHER IN CONTRACT, STRICT LIABILITY, OR TORT (INCLUDING NEGLIGENCE OR OTHERWISE) ARISING IN ANY WAY OUT OF THE USE OF THIS FONT, EVEN IF ADVISED OF THE POSSIBILITY OF SUCH DAMAGE.

Index

Symbols and Numbers

1 or 2

- channel connectors, 15
- channel menu buttons, 12

A

- AC coupling
 - trigger, 97
 - vertical, 106
- Accessories, 121
- Acquire button, 13, 15, 69
- Acquire menu, 69
- Acquire signals
 - basic concepts, 20
- Acquisition
 - live display, 71
 - single-shot example, 36
 - stopping, 71
- Acquisition modes, 20, 69
 - Average, 20, 70
 - Peak Detect, 20, 70
 - Sample, 20, 69
- Acquisition readout, 10
- Add waveforms
 - Math menu, 84
- Aliasing
 - check for, 22
 - FFT, 55
 - time domain, 21
- Amplitude cursors, 23, 79
- Amplitude measurement, 87
- Amplitude measurements
 - using cursors, 30
- Application examples
 - analyzing a differential communication signal, 45
 - analyzing signal detail, 35
 - automatic measurements, 26
 - autoranging to examine test points, 30
 - autoset, using, 26
 - averaging, using, 35

- calculating amplifier gain, 29
 - capturing a single-shot signal, 36
 - cursors, using, 30
 - data logging, 48
 - limit testing, 49
 - looking at a noisy signal, 35
 - measuring propagation delay, 38
 - measuring pulse width, 32
 - measuring ring amplitude, 30
 - measuring ring frequency, 30
 - measuring rise time, 33
 - measuring two signals, 28
 - optimizing the acquisition, 37
 - peak detect, using, 35
 - reducing noise, 35
 - taking automatic measurements, 27
 - taking cursor measurements, 30
 - triggering on a specific pulse width, 39
 - triggering on a video signal, 41
 - triggering on video fields, 41
 - triggering on video lines, 43
 - using Autorange to examine test points, 30
 - using persistence, 48
 - using the zoom function, 44
 - using XY mode, 47
 - viewing impedance changes in a network, 46
- Area measurement, 89
 - Attenuation
 - voltage probe, 6, 106
 - Attenuation switch, 7
 - Auto trigger mode, 97
 - Automatic measurements, 85
 - basic concepts, 24
 - Autorange functions, 17
 - overview, 71
 - turning off, 72

- Autorange menu, 71
- Autoset
 - button, 15
- Autoset functions, 17
 - DC level, 73
 - FFT, 75
 - noise, 74
 - overview, 73
 - pulse signal, 75
 - sine waves, 74
 - square wave, 75
 - Undo, 75
 - video signal, 75
 - when to use, 74
- Autoset menu, 73
- Average
 - acquisition mode, 69
- Average acquisition mode, 20, 70

B

- Bandwidth limit
 - trigger, 97
 - vertical, 106
- BMP file format, 64
- Burst Width measurement, 87
- BW limit for vertical, 106

C

- Calendar, 104
- Calibration, 101, 102
 - automatic routine, 7
- Center graticule time readout, 10
- Channel
 - coupling, 106
 - menu, 106
- Channel readout, 11
- Cleaning, 123
- Clock
 - set date and time, 104
- Coarse resolution, 106
- Communication
 - OpenChoice software installation, 65

- Compensation
 - PROBE COMP connector, 15
 - voltage probe manual, 6
 - Connectors
 - Channels 1 and 2, 15
 - Ext Trig, 15
 - PROBE COMP, 15
 - USB Device port, 65
 - USB Flash Drive port, 59
 - Cooling by convection, 3
 - Counter, 76
 - Coupling
 - trigger, 19, 98
 - vertical, 106, 107
 - Course
 - Load course, 77
 - Run labs, 77
 - CSV file format, 93
 - Current folder, 60, 104
 - Current probes
 - scale setting, 7, 106
 - Cursor button, 15, 79
 - Cursor menu, 79
 - Cursors
 - adjusting, 79
 - Amplitude, 23, 79
 - basic concepts, 23
 - Frequency for FFT, 79
 - Magnitude for FFT, 79
 - measurement examples, 30
 - measuring an FFT
 - spectrum, 58
 - Time, 24, 79
 - using, 79
 - Cycle Area measurement, 89
 - Cycle mean measurement, 88
 - Cycle RMS measurement, 88
- D**
- Data logging
 - application example, 48
 - Date, 104
 - DC coupling
 - trigger, 97
 - vertical, 106
 - Default setup
 - recalling, 94
 - Default Setup, 80
 - Default Setup button, 15
 - option and control settings, 125
 - retained option settings, 126
 - Delay measurement
 - Falling to falling, 86
 - Falling to rising, 86
 - Rising to falling, 86
 - Rising to rising, 86
 - Delayed sweep, 84
 - Deleting
 - files or folders, 105
 - Deleting files or folders, 100
 - Delta readouts in Cursor menu, 79
 - Description
 - general, 1
 - Diagonal lines in waveform
 - peak detect, 70
 - Directories
 - deleting, 100, 105
 - Display
 - intensity, 80
 - menu, 80
 - persistence, 80
 - readouts, 9
 - style (Invert), 106
 - style of waveforms, 80
 - type: vectors or dots, 80
 - XY format, 80
 - YT format, 80
 - Displaying waveforms, 106
 - reference, 90
 - Do Self Cal option, 7
 - Dots display type, 80
- E**
- Edge trigger, 96
 - Error Log, 103
 - Ext Trig connector, 15
- F**
- Factory calibration, 104
 - Factory setup, 125
 - recalling, 94
 - Fall Time measurement, 86
 - Falling edge count
 - measurement, 88
 - Features
 - overview, 1
 - FFT, 51, 53, 82
 - FFT aliasing, 55
 - remedies, 57
 - FFT spectrum
 - applications, 51
 - displaying, 53
 - magnify, 57
 - measuring magnitude
 - and frequency with cursors, 58
 - Nyquist frequency, 52
 - process, 51
 - readouts, 53
 - window, 54
 - FFT window
 - Flattop, 55
 - Hanning, 55
 - Rectangular, 55
 - FFT zoom
 - horizontal, 53
 - vertical, 52
 - Field video trigger, 98
 - File formats for images, 64
 - File utilities, 104
 - creating files or folders, 105
 - deleting files or folders, 100, 105
 - navigating the directory structure, 105
 - renaming files or folders, 105
 - selecting files or folders, 104
 - USB flash drive contents, 104
 - Fine resolution, 106
 - Firmware update
 - Internet, 8
 - Firmware updates, 105
 - Flattop window, 55
 - Folders
 - creating, 105
 - deleting, 100, 105
 - renaming, 105
 - Force trigger, 13

- Format
 - display, 80
 - image file, 64
 - USB flash drive, 60
 - Frequency
 - trigger readout, 100
 - Frequency cursors, 24
 - FFT spectrum, 58
 - Frequency measurement, 86
 - Frequency measurements
 - FFT cursors, 58
 - using cursors, 30
 - Function, 82
 - Functional check, 4
- G**
- GPIB adapter
 - ordering, 122
 - GPIB system
 - connecting to an oscilloscope, 67
 - Graticule, 23, 80
 - Ground coupling, 106
- H**
- Hanning window, 55
 - Help, 84
 - Help button, 15
 - High measurement, 87
 - Holdoff, 101
 - Horizontal
 - aliasing, time domain, 21
 - menu, 84
 - position, 21
 - scale, 21
 - Scan mode, 71, 84
 - status, 103
 - Horizontal position/scale
 - readout, 11
 - Horizontal scale control, 13
 - Horizontal Scale control, 84
 - How to
 - select automatic measurements, 86
- I**
- Image file formats, 64
 - Infrequent events
 - infinite persistence, 81
 - Installation
 - OpenChoice software on a PC, 65
 - Intensity, 80
 - Interpolation, 70
- J**
- JPG file format, 64
- L**
- Languages, 101, 102
 - Level, 13, 20
 - Level control, 13
 - Limit testing
 - application example, 49
 - Line video trigger, 98
 - Lissajous pattern
 - XY format, 81
 - Low measurement, 88
- M**
- Magnitude cursors, 23
 - FFT spectrum, 58
 - Manuals ordering, 122
 - Math
 - functions, 84
 - menu, 84
 - Math Menu button, 12
 - math waveform
 - allowed units, 85
 - Max measurement, 88
 - Mean measurement, 88
 - Measure button, 15
 - Measure menu, 85
 - Measurements
 - DelayFF, 86
- Measurements**
- Amplitude, 87
 - Area, 89
 - automatic, 24, 85
 - basic concepts, 23
 - Burst width, 87
 - cursor, 23, 30
 - Cycle area, 89
 - Cycle mean, 88
 - Cycle RMS, 88
 - defined, 86
 - DelayFR, 86
 - DelayRF, 86
 - DelayRR, 86
 - Fall time, 86
 - Falling edge count, 88
 - FFT spectrum, 58
 - Frequency, 86
 - graticule, 23
 - High, 87
 - Low, 88
 - Max, 88
 - Mean, 88
 - Min, 88
 - Negative duty cycle, 86
 - Negative overshoot, 87
 - Negative pulse count, 89
 - Negative pulse width, 86
 - Peak-to-peak, 87
 - Period, 86
 - Phase, 87
 - Positive duty cycle, 86
 - Positive overshoot, 87
 - Positive pulse count, 89
 - Positive pulse width, 86
 - Rise time, 86
 - Rising edge count, 88
 - RMS, 88
 - types, 85
 - Memory
 - screen images, 91
 - setups, 91
 - USB flash drive, 59
 - waveforms, 91
 - Menu system
 - using, 12

Menus

- Acquire, 69
 - Autorange, 71
 - Autoset, 73
 - Cursor, 79
 - Display, 80
 - FFT, 53
 - Help, 84
 - Horizontal, 84
 - Math, 84
 - Measure, 85
 - Ref, 90
 - Save/Recall, 91
 - Trigger, 96
 - Utility, 101
 - Vertical, 106
- Messages, 11
- Min measurement, 88
- Multiply waveforms
- Math menu, 84
- Multipurpose knob, 14

N

Navigation

- file system, 104
- Negative Duty Cycle measurement, 86
- Negative Overshoot measurement, 87
- Negative pulse count measurement, 89
- Negative Pulse Width measurement, 86
- Noise reduction
- Average mode, 69
 - Math subtraction, 85
 - trigger coupling, 97
 - vertical bandwidth limit, 106
- Nonvolatile memory
- reference waveform files, 91
 - setup files, 91
- Normal operation
- recall default setup, 18
- Normal trigger mode, 97
- NTSC video standard, 98
- Nyquist
- frequency, 52

O

- OpenChoice software
- installation, 65
- Oscilloscope
- connecting to a GPIB system, 67
 - connecting to a PC, 66
 - front panels, 9
 - set date and time, 104
 - understanding functions, 17

P

- PAL video standard, 98
- Panning
- horizontal, 21
 - vertical, 21
- PC
- connecting to an oscilloscope, 66
- Peak Detect acquisition mode, 20, 70
- Peak Detect mode, 69
- Peak-to-peak measurement, 87
- Peak-to-peak noise, 81
- Period measurement, 86
- Persistence, 80, 81
- Phase differences, 81
- Phase measurement, 87
- Polarity
- Pulse Width trigger, 99
 - Video trigger sync, 98
- Ports
- USB flash drive, 59
- Position
- horizontal, 21, 84
 - trigger, 98
 - vertical, 106
- Position control
- horizontal, 13
 - vertical, 12
- Positive Duty Cycle measurement, 86
- Positive Overshoot measurement, 87
- Positive pulse count measurement, 89

- Positive Pulse Width measurement, 86
- Power, 2
- Power cords, 2
- ordering, 122
- Power Cycle count, 103
- Pretrigger, 18
- Pretrigger view, 98
- PROBE COMP connections, 15
- Probe option
- match current probe scale, 7
 - match voltage probe attenuation, 6
- Probes
- Attenuation switch, 6
 - compensation, 15
 - current and scale, 7
 - safety, 5
 - voltage and attenuation, 106
 - voltage probe manual compensation, 6
- Programmer manual
- ordering, 122
- Pulse signal
- Autoset function, 75
- Pulse width measurements
- using cursors, 32
- Pulse Width triggering, 99

R

Readout

- Acquisition, 10
 - Center graticule time, 10
 - Channel, 11
 - FFT, 53
 - general, 9
 - Horizontal position/scale, 11
 - Trigger, 11
 - Trigger status, 10
- Recall
- factory setup (default), 18
 - setups, 18, 94
 - waveforms, 95
- Recall Setup menu, 93
- Recall Waveform menu, 94
- Rectangular window, 55
- Ref button, 15

- Ref menu, 90
 - Reference
 - lead for probe, 5
 - probe terminal, 5
 - terminal, 15
 - Reference waveforms
 - displaying and removing, 90
 - saving and recalling, 95
 - Remote control using a GPIB interface, 67
 - Removable file storage
 - USB flash drive, 59
 - Removing reference waveforms, 90
 - Removing waveforms, 106
 - Renaming files or folders, 105
 - Resolution
 - fine, 107
 - Rise Time measurement, 86
 - Rise time measurements
 - using cursors, 33
 - Rising edge count
 - measurement, 88
 - RMS measurement, 88
 - Roll mode *See* Scan mode
 - Run/Stop button, 15, 70
 - steps taken by the oscilloscope when pushed, 18
- S**
- Sample acquisition mode, 20, 69
 - Sample rate
 - maximum, 69
 - Save
 - setups, 18
 - Save All menu, 91
 - Save button, 15
 - Save Button option
 - saving to a USB flash drive, 63
 - Save Image menu, 92
 - Save Setup menu, 92
 - Save to a USB flash drive, 59
 - Save Waveform menu, 93
 - Save/Recall button, 15
 - Save/Recall menu, 91
 - saving to a USB flash drive, 61
 - Saving
 - all files to a USB flash drive, 63
 - image files to a USB flash drive, 64
 - setups, 94
 - waveforms, 95
 - Scale
 - control, 12
 - Course, 106
 - current probe, 7, 106
 - Fine, 106
 - horizontal, 21
 - vertical, 21
 - Scaling waveforms
 - basic concepts, 21
 - Scan mode, 71, 84
 - Scanning waveforms, 84
 - Screen image
 - saving to a file, 64
 - SECAM video standard, 98
 - Security loop, 2
 - Self calibration, 7
 - Service
 - error log as a reference, 103
 - Service manual ordering, 122
 - Set date and time, 104
 - Set to 50%, 13
 - Set To Zero button, 13
 - Setups
 - basic concepts, 17
 - saving and recalling, 91
 - Sine waves
 - Autoset function, 74
 - Single button, 15, 70
 - steps taken by the oscilloscope when pushed, 18
 - Single-shot signal
 - application example, 36
 - Slope, 20
 - Soft case ordering, 122
 - Source
 - AC Line, 98
 - Ext, 97
 - Ext/5, 97
 - trigger, 19, 96, 98, 99
 - Specifications
 - oscilloscope, 109
 - Square wave
 - Autoset function, 75
 - Status
 - miscellaneous, 103
 - system, 101
 - Subtract waveforms
 - Math menu, 84
 - Sweep
 - delayed, 84
 - horizontal scale, 84
 - Sync
 - video polarity, 98
 - video trigger line or field, 98
 - Sync pulse, 98
- T**
- TEK-USB-488 adapter
 - connecting, 67
 - ordering, 122
 - Time base, 13, 20
 - Time cursors, 24, 79
 - Time domain
 - waveform, 51
 - Transit case ordering, 122
 - Trend plot, 95

Trigger

- coupling, 19, 97, 98
 - definition, 18
 - edge, 96
 - force, 100
 - Force trigger, 13
 - frequency readout, 100
 - holdoff, 101
 - level, 13, 20, 96
 - menu, 96
 - modes, 19
 - modes: Auto, 97
 - modes: Normal, 97
 - polarity, 99
 - position, 19
 - Position icon, 10
 - pretrigger information, 98
 - slope, 20, 96
 - source, 19, 96, 99
 - status, 103
 - sync, 98
 - types, 19
 - video, 98, 99
 - view, 100
- Trigger level icon, 10
- Trigger Menu button, 13
- Trigger readout, 11
- Trigger status readout, 10
- Trigger view, 13

U

- USB Device port, 65

USB flash drive

- file management, 60
 - File utilities, 104
 - formatting, 60
 - installation, 59
 - port location, 16, 59
 - Save button, 63
 - Save operation indicator, 59
 - Save/Recall menu, 61
 - saving files, all, 63
 - saving files, images, 64
 - saving files, setups, 63
 - saving files, waveforms, 63
 - storage capacity, 60
- USB Flash Drive port, 59
- Utility button, 15
- Utility menus, 101

V

- Vectors, 80
- Ventilation, 3
- Vertical
 - menu, 106
 - position, 21
 - position knob, 12
 - scale, 21
 - status, 103
- Video signal
 - Autoset function, 75
- Video trigger, 98
 - application example, 41
- Volts/Div
 - Coarse, 106
 - Fine, 106

Volts/division

- control, 12

W

- Waveform baseline indicator, 11
- Waveforms
 - acquire data, 20
 - compression, 84
 - digitized, 20
 - display style meaning, 80
 - expansion, 84
 - position, 21
 - remove from screen, 107
 - scale, 21
 - scanning, 71
 - take measurements, 23
 - time domain, 51
- Windows
 - FFT spectrum, 54

X

- XY
 - application example, 47
 - display format, 80, 81

Y

- YT
 - display format, 80

Z

- Zoom, 44
 - FFT, 57